

187 BASIC WALL EXAMPLE
1 1/2" = 1'-0"

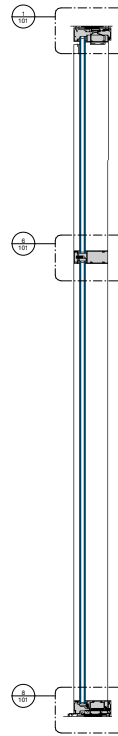

188 SECTION
1 1/2" = 1'-0"

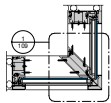

189 90° OUTSIDE CORNER
1 1/2" = 1'-0"

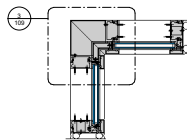

190 90° INSIDE CORNER
1 1/2" = 1'-0"

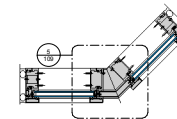

191 135° OUTSIDE CORNER
1 1/2" = 1'-0"

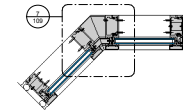

192 135° INSIDE CORNER
1 1/2" = 1'-0"

KAWNEER AN ARCONIC COMPANY

555 Guthridge Ct.
Technology Park/Atlanta
Norcross, GA 30092 USA
Tel: +1 770 449 5555

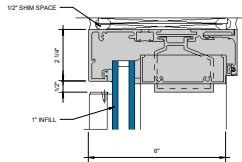

① HEAD STANDARD RECEPTOR
6" x 1-1/2"

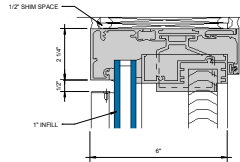

HEAD STANDARD RECEPTOR W/
② OPTIONAL BLIND POCKET
6" x 1-1/2"

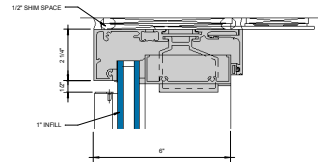

HEAD STANDARD RECEPTOR W/
③ OPTIONAL STRAP ANCHOR
6" x 1-1/2"

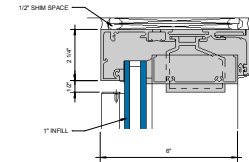

HEAD STANDARD RECEPTOR W/
④ OPTIONAL WEDGE GASKET
6" x 1-1/2"

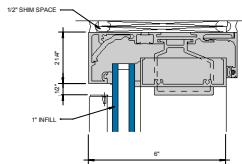

HEAD STANDARD RECEPTOR W/
⑤ REINFORCEMENT
6" x 1-1/2"

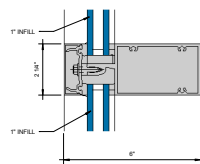

⑥ HORIZONTAL
6" x 1-1/2"

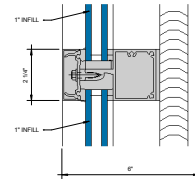

⑦ HORIZONTAL BLIND APPLICATION
6" x 1-1/2"

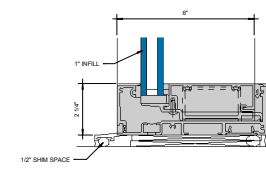

⑧ SILL STANDARD RECEPTOR
6" x 1-1/2"

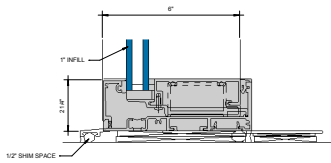

SILL STANDARD RECEPTOR W/
⑨ OPTIONAL STRAP ANCHOR
6" x 1-1/2"

KAWNEER AN ARCONIC COMPANY

555 Guthridge Ct.
Technology Park/Atlanta
Norcross, GA 30092 USA
Tel: +1 770 449 5555

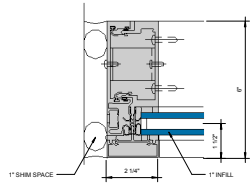

① JAMB
6" = 1'-0"

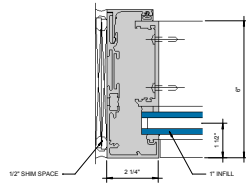

② JAMB RECEPTOR
6" = 1'-0"

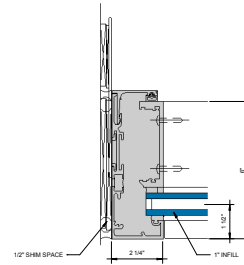

③ JAMB RECEPTOR AND STRAP ANCHOR
6" = 1'-0"

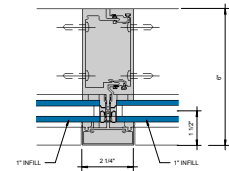

④ VERTICAL MULLION
6" = 1'-0"

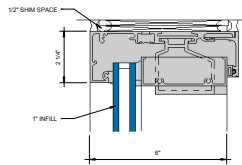

① HEAD STANDARD RECEPTOR
6" = 1'-0"

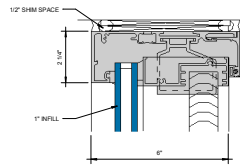

② HEAD STANDARD RECEPTOR W/
OPTIONAL BLIND POCKET
6" = 1'-0"

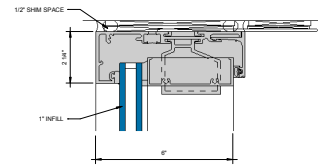

③ HEAD STANDARD RECEPTOR W/
OPTIONAL STRAP ANCHOR
6" = 1'-0"

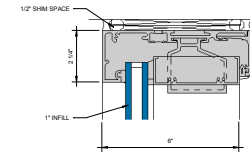

④ HEAD STANDARD RECEPTOR W/
OPTIONAL WEDGE GASKET
6" = 1'-0"

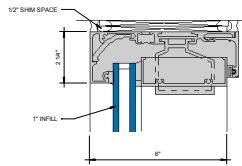

⑤ HEAD STANDARD RECEPTOR W/
REINFORCEMENT
6" = 1'-0"

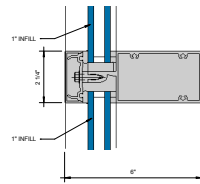

⑥ HORIZONTAL
6" = 1'-0"

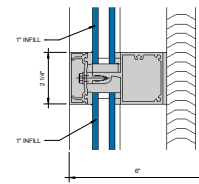

⑦ HORIZONTAL BLIND APPLICATION
6" = 1'-0"

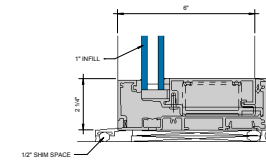

⑧ SILL STANDARD RECEPTOR
6" = 1'-0"

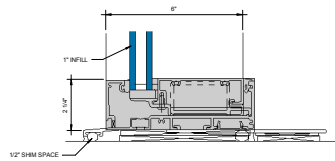

⑨ SILL STANDARD RECEPTOR W/
OPTIONAL STRAP ANCHOR
6" = 1'-0"

KAWNEER AN ARCONIC COMPANY

555 Guthridge Ct.
Technology Park/Atlanta
Norcross, GA 30092 USA
Tel: +1 770 449 5555

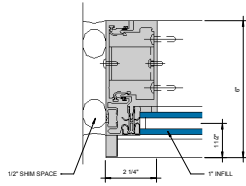

① JAMB
6" = 1'-0"

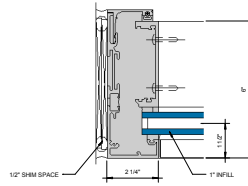

② JAMB RECEPTOR
6" = 1'-0"

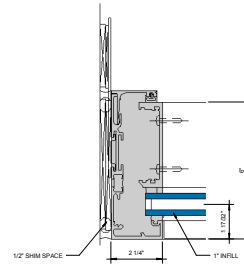

③ JAMB RECEPTOR AND STRAP ANCHOR
6" = 1'-0"

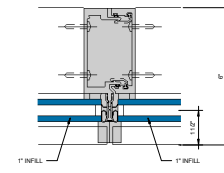

④ VERTICAL MULLION
6" = 1'-0"

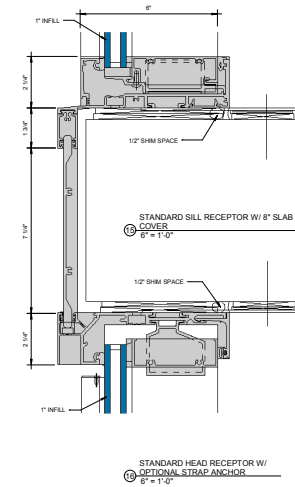
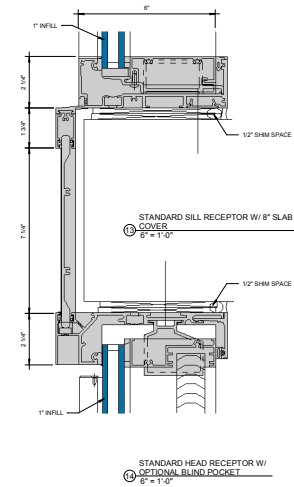
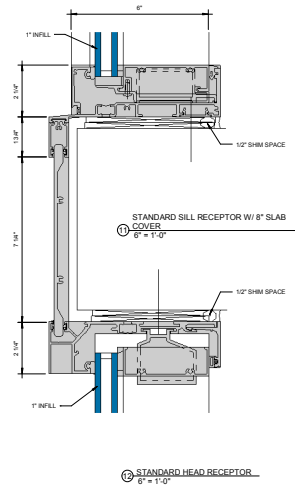
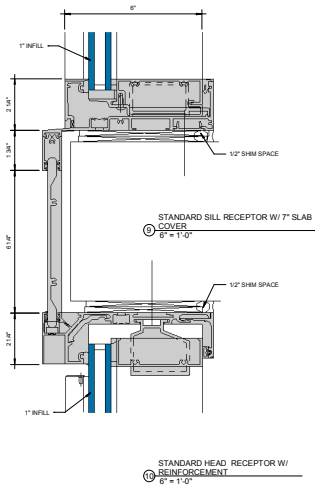
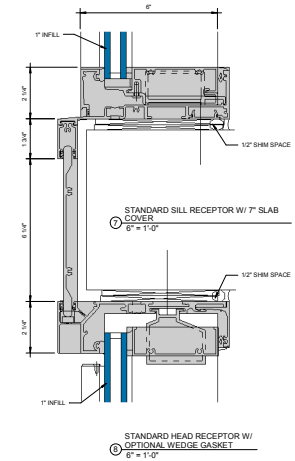
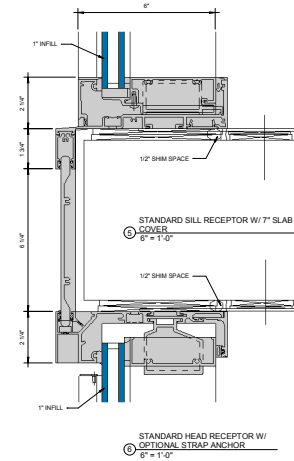
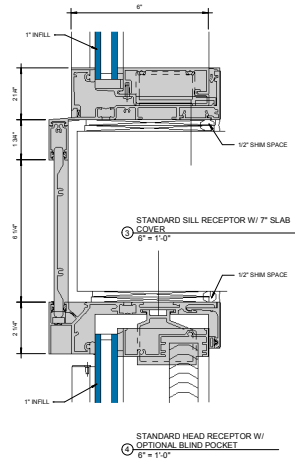
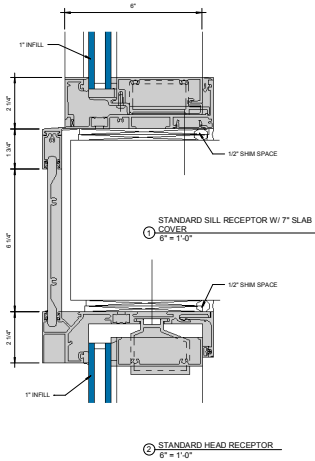

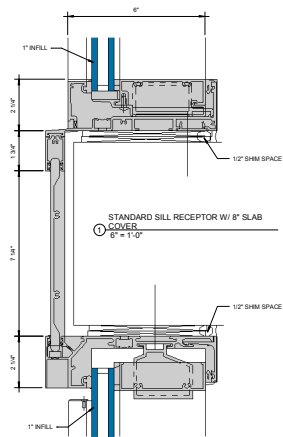

STANDARD HEAD RECEPTOR W/
OPTIONAL WEDGE GASKET
② 6" x 11-0"

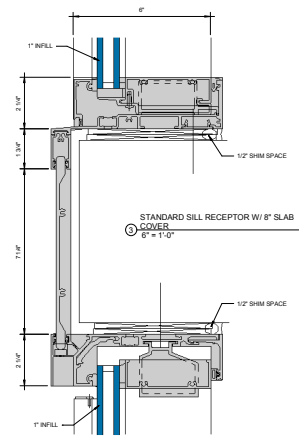

STANDARD HEAD RECEPTOR W/
REINFORCEMENT
④ 6" x 11-0"

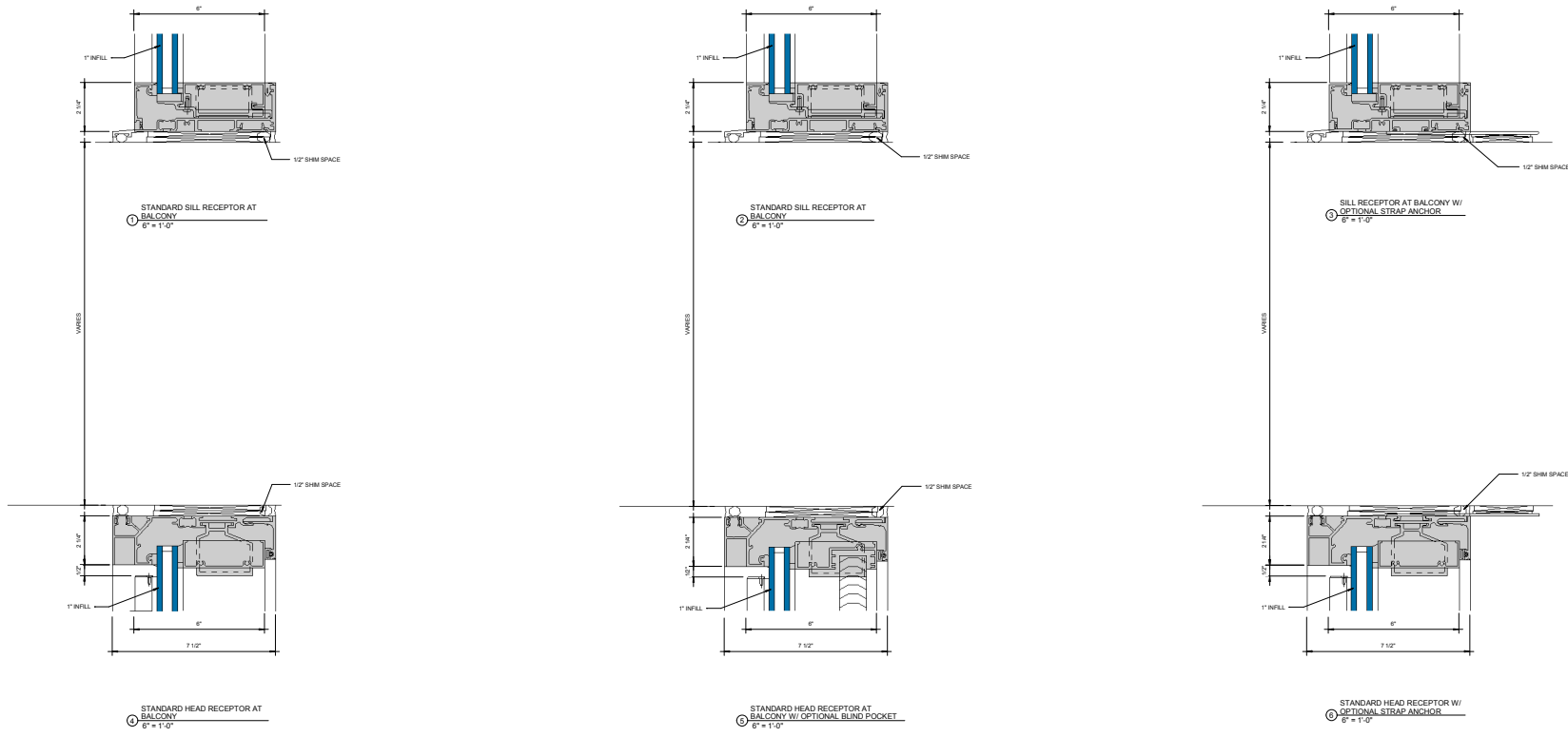

KAWNEER AN ARCONIC COMPANY

555 Guthridge Ct.
Technology Park/Atlanta
Norcross, GA 30092 USA
Tel: +1 770 449 5555

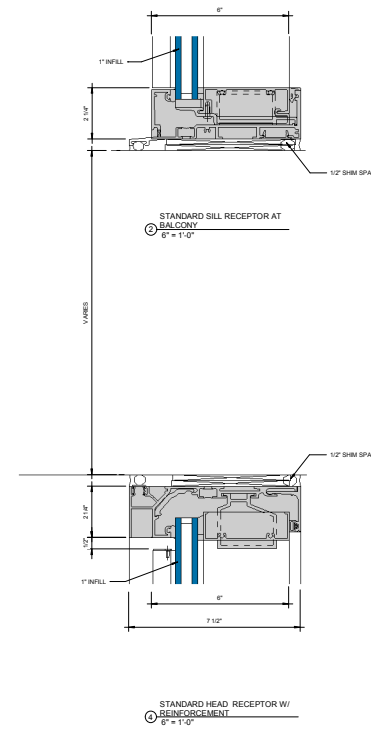
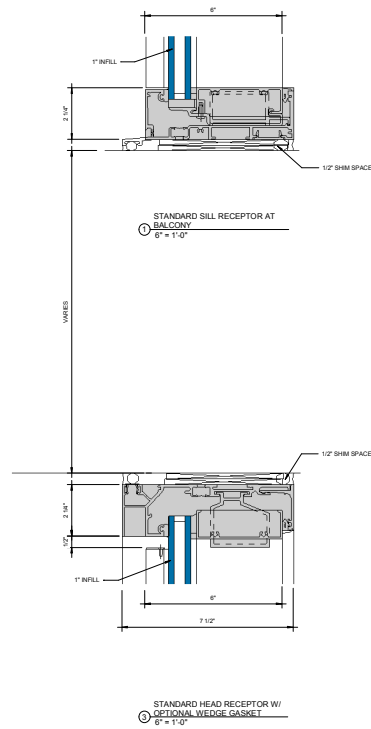

METROVIEW™ FG 601T PG WINDOW WALL- (SSG) 1" Infill Wet Glazed Framing Details Standard Receptor with Slab Cover

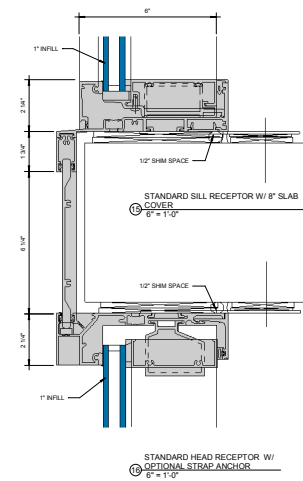
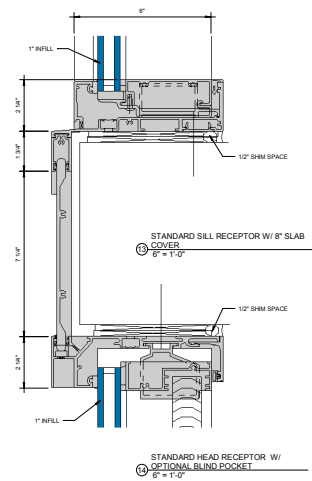
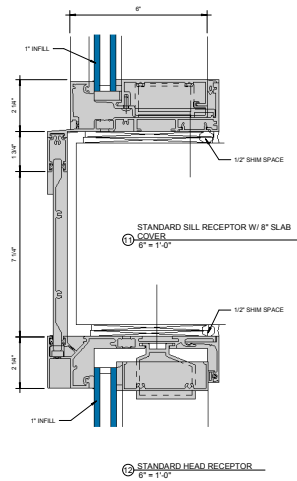
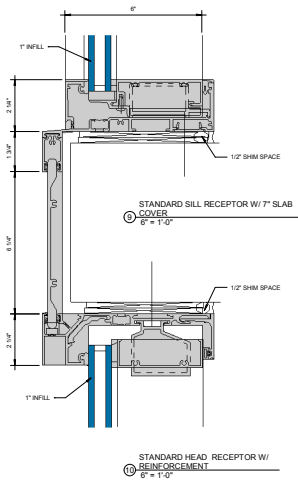
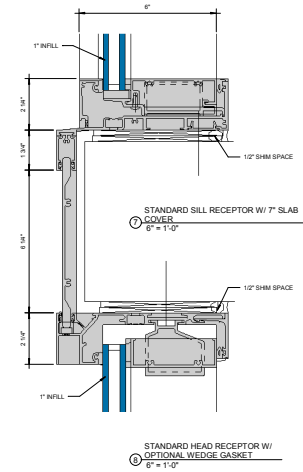
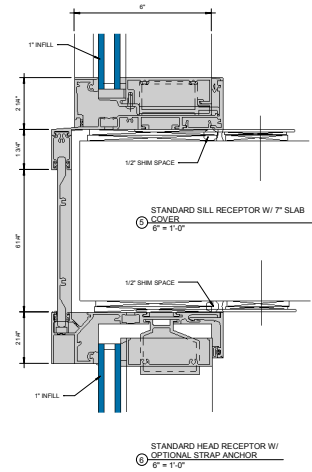
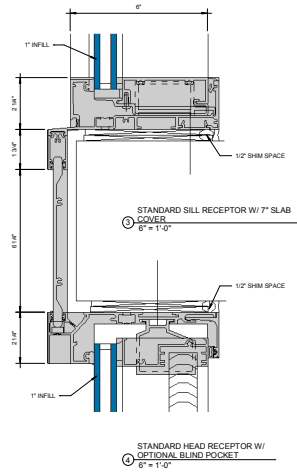
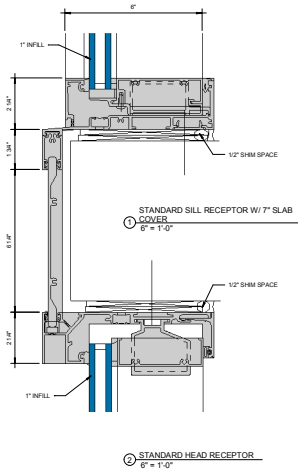

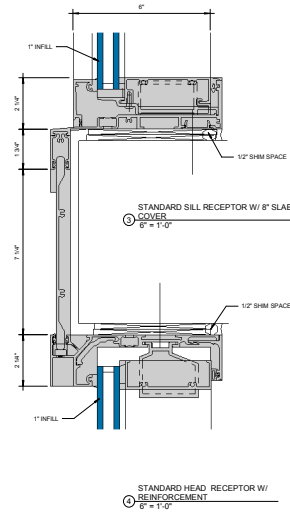
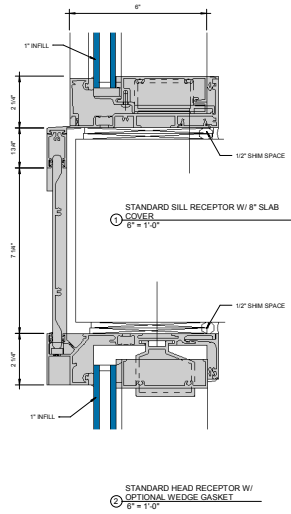

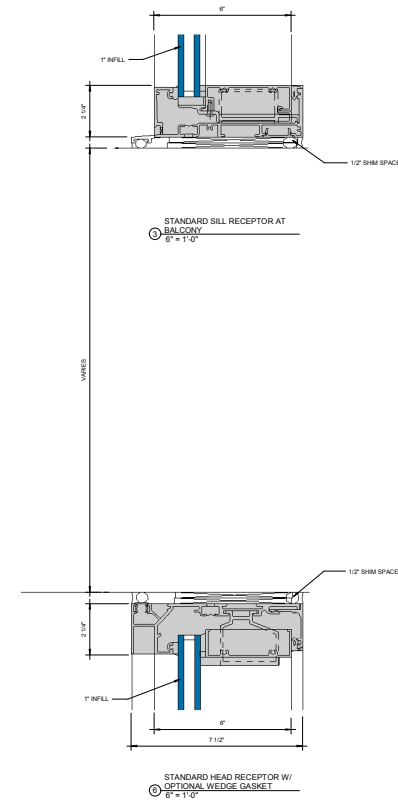
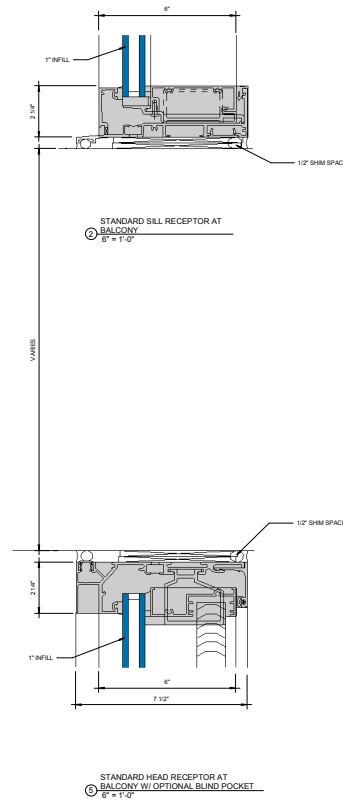
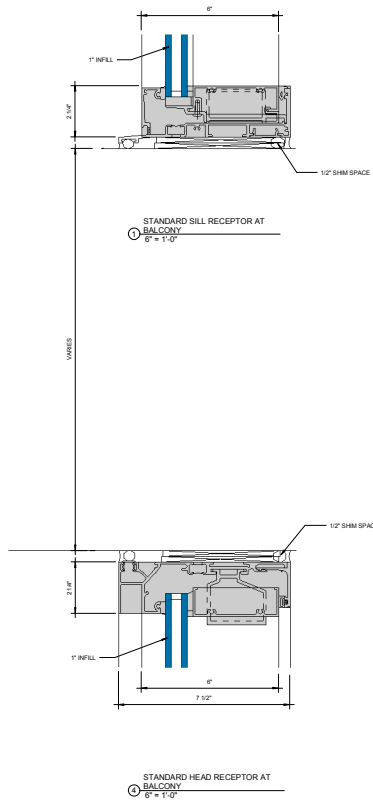

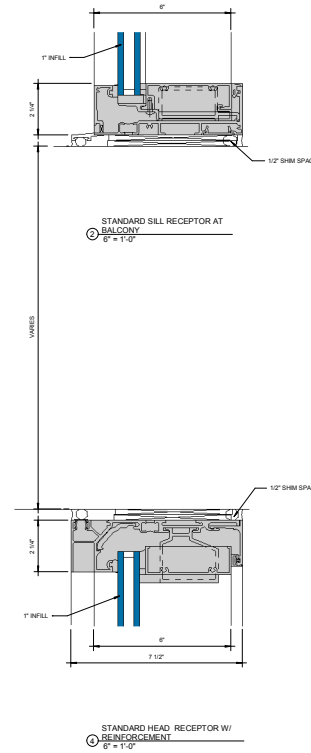
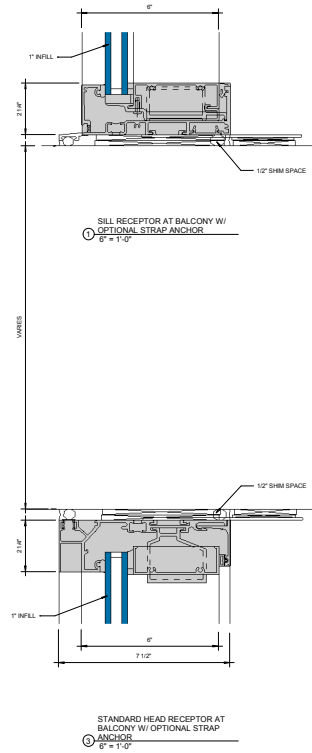

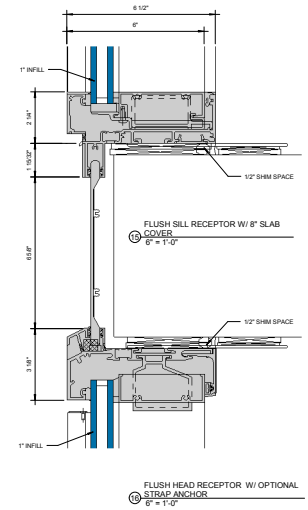
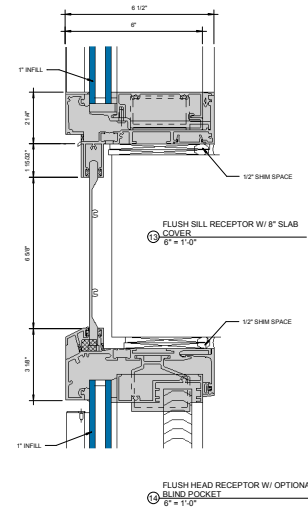
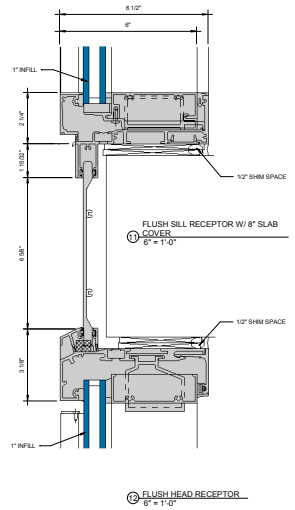
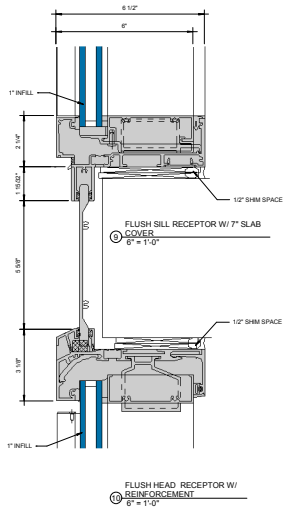
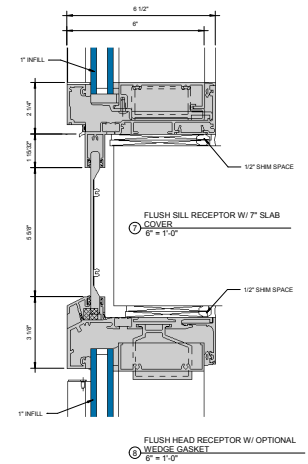
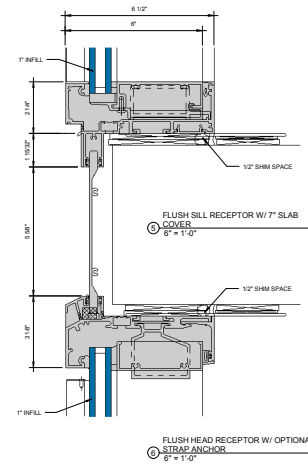
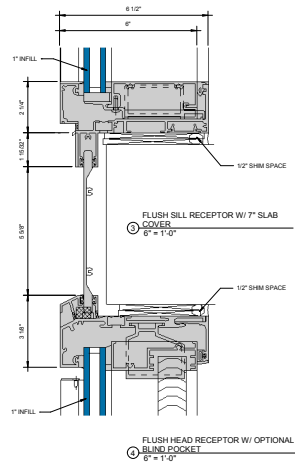
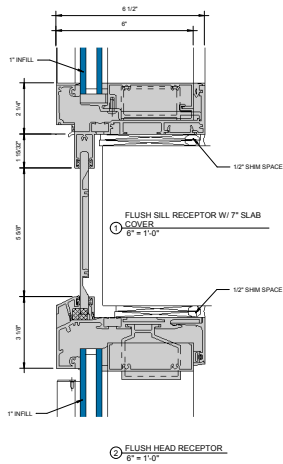

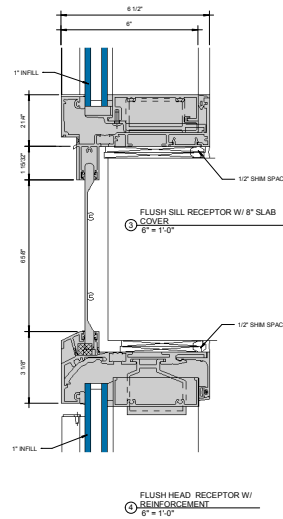
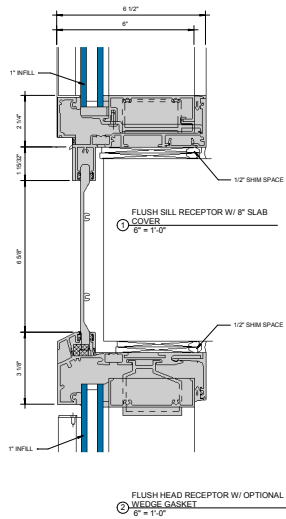

METROVIEW™ FG 601T PG WINDOW WALL- (SSG) 1" Infill Wet Glazed Typical Framing Details Flush Receptor with Slab Cover

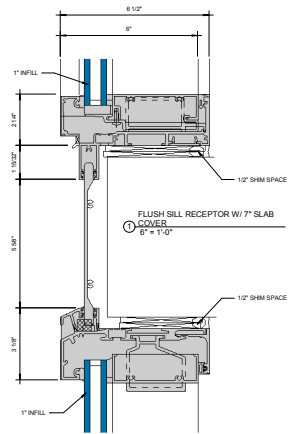

① FLUSH HEAD RECEPTOR
② 6" x 1"-0"

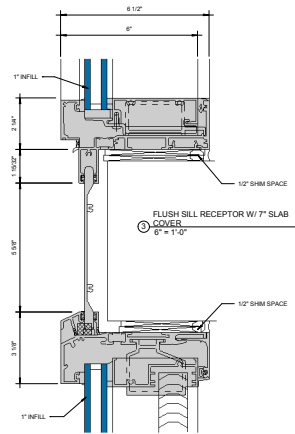

FLUSH HEAD RECEPTOR W/ OPTIONAL
① BLIND POCKET
② 6" x 1"-0"

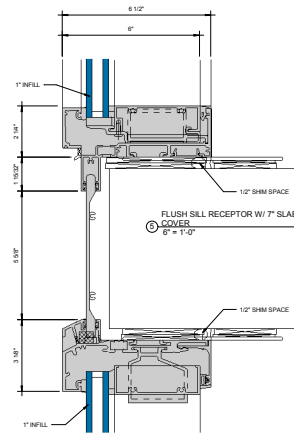

FLUSH HEAD RECEPTOR W/ OPTIONAL
① STRAP ANCHOR
② 6" x 1"-0"

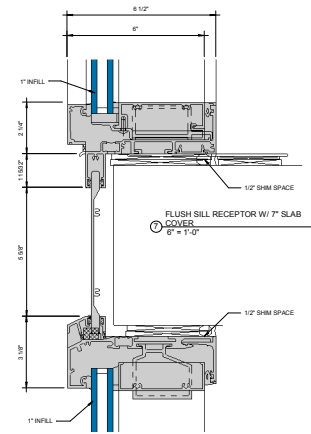

FLUSH HEAD RECEPTOR W/ OPTIONAL
① WEDGE GASKET
② 6" x 1"-0"

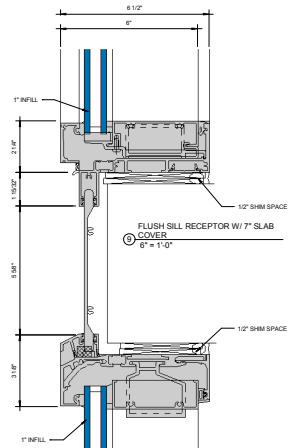

FLUSH HEAD RECEPTOR W/
① REINFORCEMENT
② 6" x 1"-0"

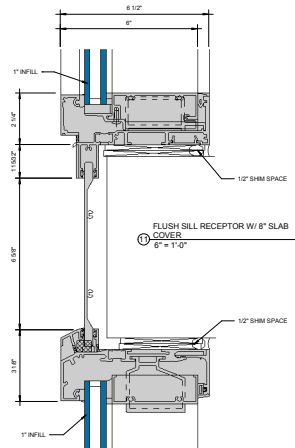

① FLUSH HEAD RECEPTOR
② 6" x 1"-0"

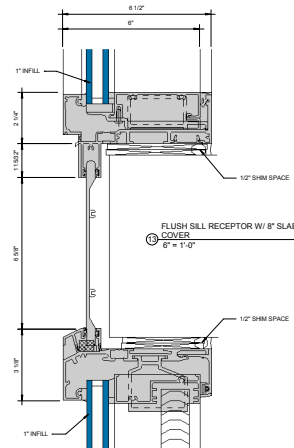

FLUSH HEAD RECEPTOR W/ OPTIONAL
① BLIND POCKET
② 6" x 1"-0"

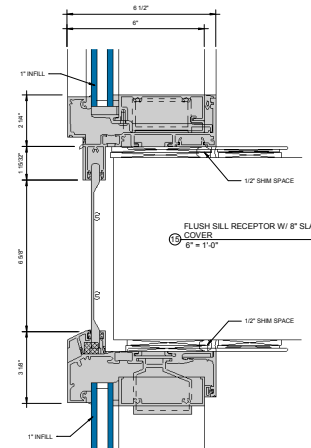

FLUSH HEAD RECEPTOR W/ OPTIONAL
① STRAP ANCHOR
② 6" x 1"-0"

KAWNEER AN ARCONIC COMPANY

555 Guthridge Ct.
Technology Park/Atlanta
Norcross, GA 30092 USA
Tel: +1 770 449 5555

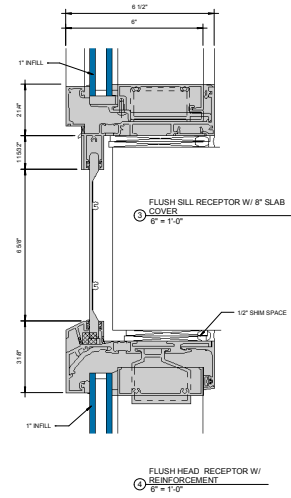
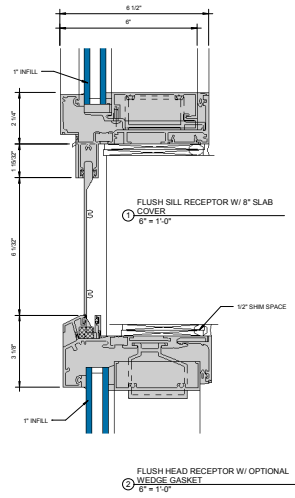

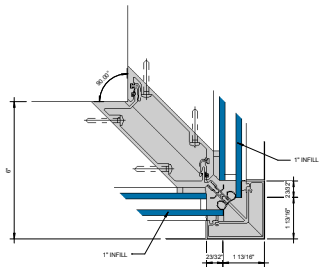

① 90° OUTSIDE CORNER
G = 1'-0"

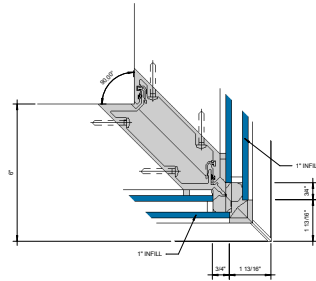

② 90° OUTSIDE CORNER (SSG)
G = 1'-0"

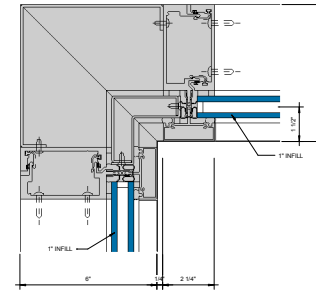

③ 90° INSIDE CORNER
G = 1'-0"

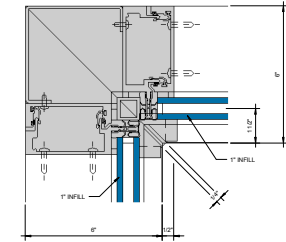

④ 90° INSIDE CORNER (SSG)
G = 1'-0"

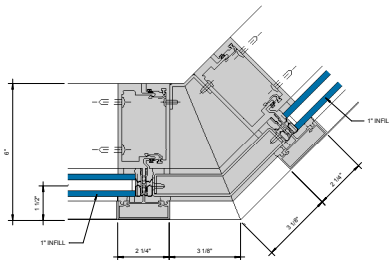

⑤ 135° OUTSIDE CORNER
G = 1'-0"

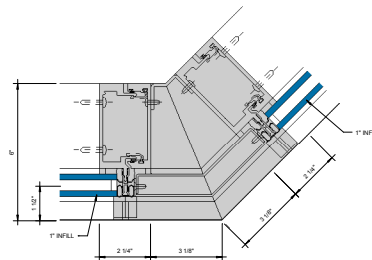

⑥ 135° OUTSIDE CORNER (SSG)
G = 1'-0"

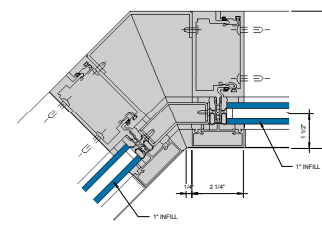

⑦ 135° INSIDE CORNER
G = 1'-0"

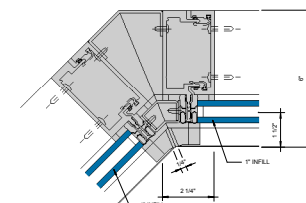

⑧ 135° INSIDE CORNER (SSG)
G = 1'-0"

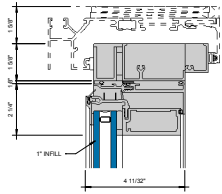

GLASSvent UT HEAD AT HEAD
RECEPTOR POICOS
①
6" = 1'-0"

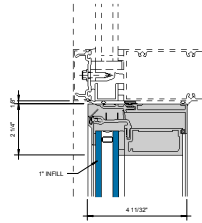

GLASSvent UT HEAD AT HORIZONTAL
RECEPTOR
①
6" = 1'-0"

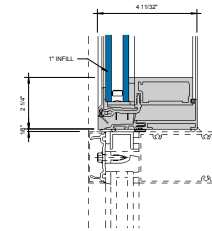

GLASSvent UT SILL AT HORIZONTAL
RECEPTOR
①
6" = 1'-0"

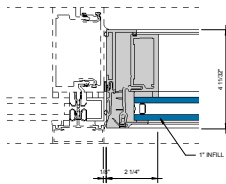

GLASSvent UT JAMB (LH) AT VERTICAL
RECEPTOR
①
6" = 1'-0"

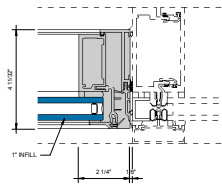

GLASSvent UT JAMB (RH) AT VERTICAL
RECEPTOR
①
6" = 1'-0"

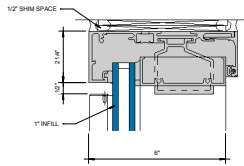

TRANSOM HEAD W/ PUNCHED OPENING RECEPTOR
①
6" = 1'-0"

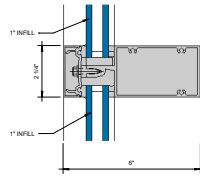

② HORIZONTAL
6" = 1'-0"

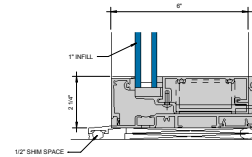

③ SILL W/ PUNCHED OPENING RECEPTOR
6" = 1'-0"

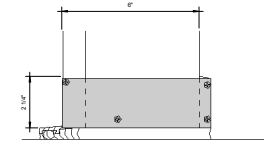

④ SILL END CAP @ DOOR JAMB
6" = 1'-0"

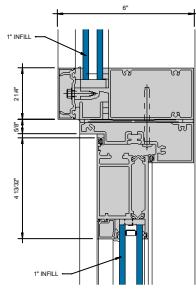

2000T TERRACE DOOR HEADER @ HORIZONTAL
①
6" = 1'-0"

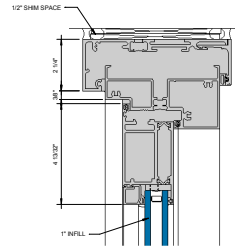

2000T TERRACE DOOR HEADER W/ PUNCHED OPENING RECEPTOR
①
6" = 1'-0"

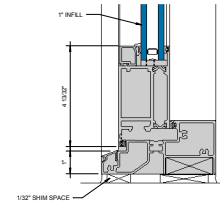

① 2000T TERRACE DOOR SILL
6" = 1'-0"

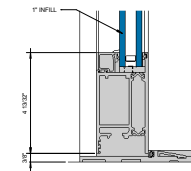

2000T TERRACE DOOR LOW PROFILE SILL
①
6" = 1'-0"

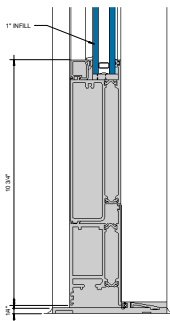

① 2000L TERRACE DOOR 10\"/>

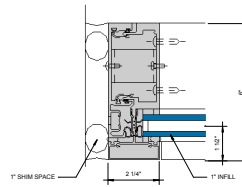

① JAMB
6" = 1'-0"

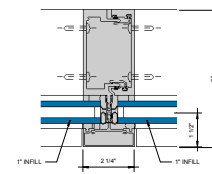

① VERTICAL MULLION
6" = 1'-0"

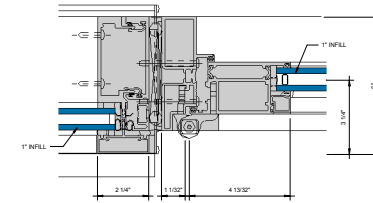

① DOOR JAMB @ HINGE STILE
6" = 1'-0"

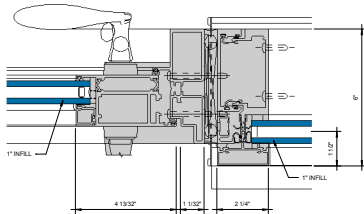

① DOOR JAMB @ LOCK STILE
Ø = 1'-0"

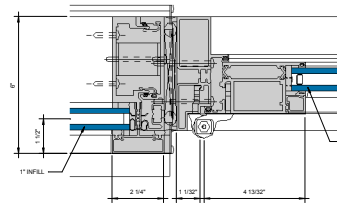

② DOOR JAMB @ HINGE STILE
Ø = 1'-0"

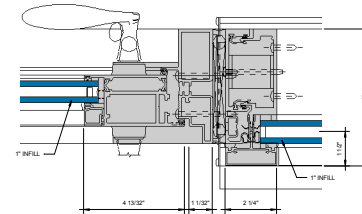

③ DOOR JAMB @ LOCK STILE
Ø = 1'-0"

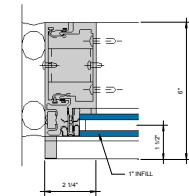

④ ALT. SSG JAMB
Ø = 1'-0"

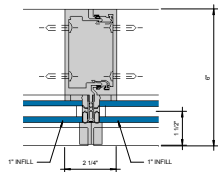

⑤ ALT. SSG VERTICAL MULLION
Ø = 1'-0"

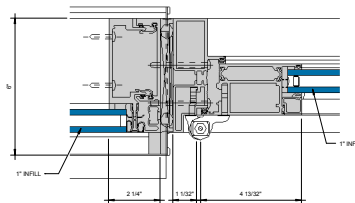

⑥ ALT. SSG DOOR JAMB @ HINGE STILE
Ø = 1'-0"

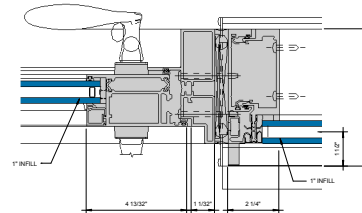

⑦ ALT. SSG DOOR JAMB @ LOCK STILE
Ø = 1'-0"

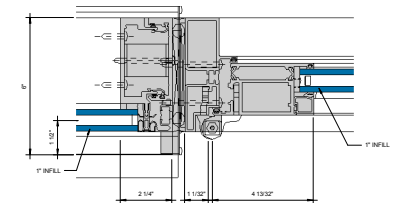

⑧ ALT. SSG DOOR JAMB @ HINGE STILE
Ø = 1'-0"

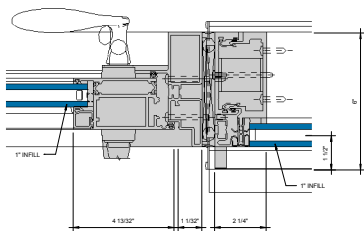

⑨ ALT. SSG DOOR JAMB @ LOCK STILE
Ø = 1'-0"

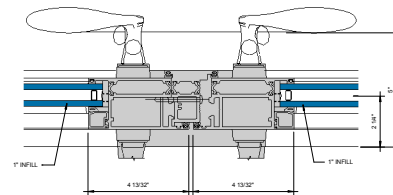

⑩ 2000T DOOR MEETING STILES
Ø = 1'-0"

KAWNEER AN ARCONIC COMPANY

555 Guthridge Ct.
Technology Park/Atlanta
Norcross, GA 30092 USA
Tel: +1 770 449 5555

METROVIEW™ FG 601T PG WINDOW WALL - 1" Infill Wet Glazed with 2000T Terrace Door – Inswing Typical Entrance Framing Details

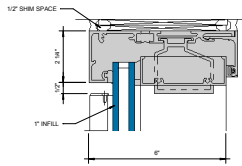

TRANSOM HEAD W/ PUNCHED OPENING RECEPTOR
①
6" = 1'-0"

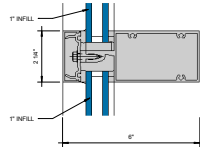

② HORIZONTAL
6" = 1'-0"

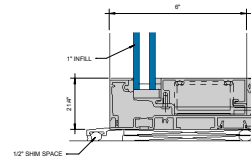

③ SILL W/ PUNCHED OPENING RECEPTOR
6" = 1'-0"

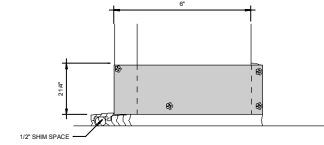

④ SILL END CAP @ DOOR JAMB
6" = 1'-0"

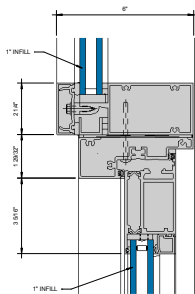

2000T TERRACE DOOR HEADER @ HORIZONTAL
⑤
6" = 1'-0"

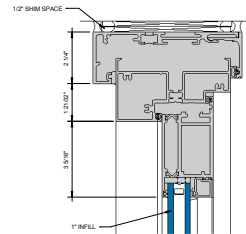

2000T TERRACE DOOR HEADER W/ PUNCHED OPENING RECEPTOR
⑥
6" = 1'-0"

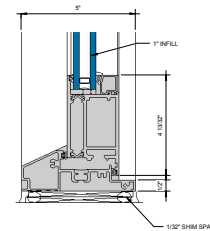

⑦ 2000T TERRACE DOOR SILL
6" = 1'-0"

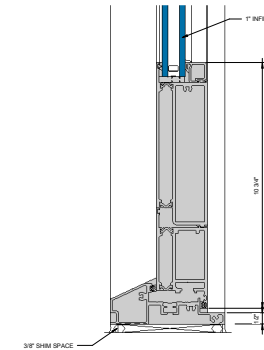

⑧ 2000T TERRACE DOOR 10" TALL SILL
6" = 1'-0"

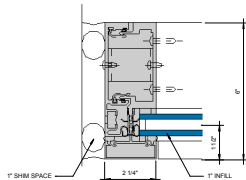

⑨ JAMB
6" = 1'-0"

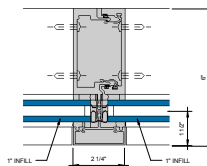

⑩ VERTICAL MULLION
6" = 1'-0"

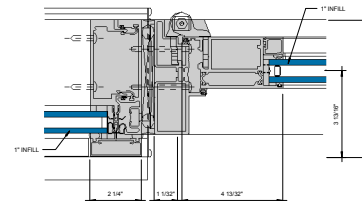

⑪ DOOR JAMB @ HINGE STILE
6" = 1'-0"

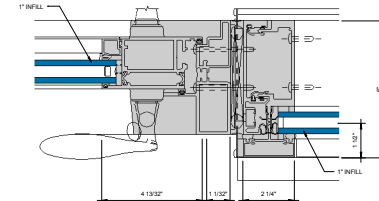

⑫ DOOR JAMB @ LOCK STILE
6" = 1'-0"

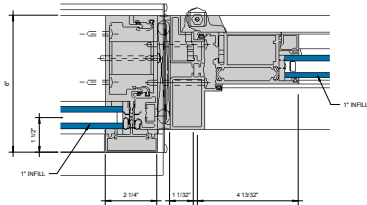

① DOOR JAMB @ HINGE STILE
6" = 1'-0"

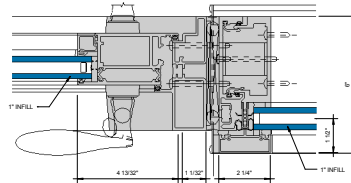

② DOOR JAMB @ LOCK STILE
6" = 1'-0"

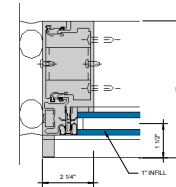

③ ALT. SSG JAMB
6" = 1'-0"

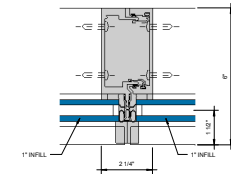

④ ALT. SSG VERTICAL MULLION
6" = 1'-0"

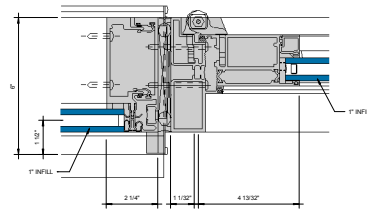

⑤ ALTERNATE SSG DOOR JAMB @ HINGE STILE
6" = 1'-0"

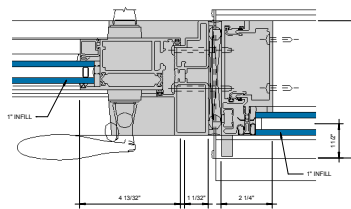

⑥ ALTERNATE SSG DOOR JAMB @ LOCK STILE
6" = 1'-0"

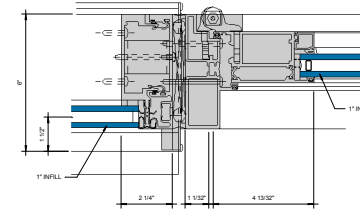

⑦ ALTERNATE SSG DOOR JAMB @ HINGE STILE
6" = 1'-0"

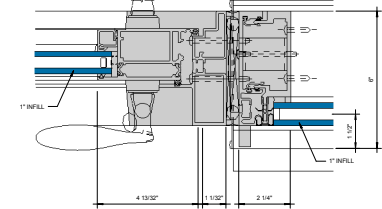

⑧ ALTERNATE SSG DOOR JAMB @ LOCK STILE
6" = 1'-0"

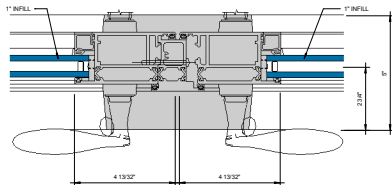

⑨ MEETING STILES
6" = 1'-0"

KAWNEER AN ARCONIC COMPANY

555 Guthridge Ct.
Technology Park/Atlanta
Norcross, GA 30092 USA
Tel: +1 770 449 5555

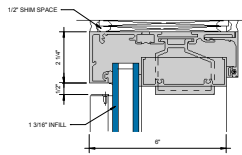

① HEAD STANDARD RECEPTOR
6" = 1'-0"

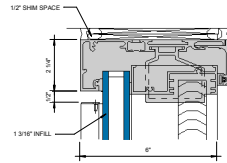

② HEAD STANDARD RECEPTOR W/
OPTIONAL BLIND POCKET
6" = 1'-0"

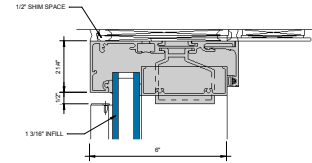

③ HEAD STANDARD RECEPTOR W/
OPTIONAL STRAP ANCHOR
6" = 1'-0"

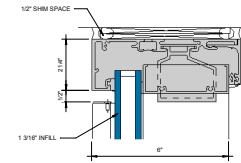

④ HEAD STANDARD RECEPTOR W/
OPTIONAL WEDGE GASKET
6" = 1'-0"

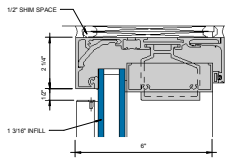

⑤ HEAD STANDARD RECEPTOR W/
REINFORCEMENT
6" = 1'-0"

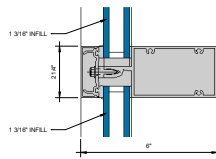

⑥ HORIZONTAL
6" = 1'-0"

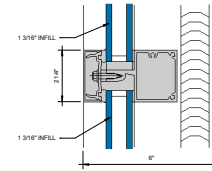

⑦ HORIZONTAL BLIND APPLICATION
6" = 1'-0"

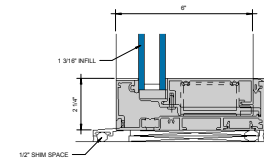

⑧ SILL STANDARD RECEPTOR
6" = 1'-0"

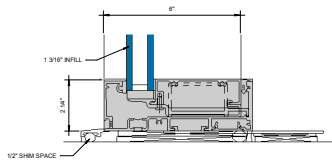

⑨ SILL STANDARD RECEPTOR W/
OPTIONAL STRAP ANCHOR
6" = 1'-0"

KAWNEER AN ARCONIC COMPANY

555 Guthridge Ct.
Technology Park/Atlanta
Norcross, GA 30092 USA
Tel: +1 770 449 5555

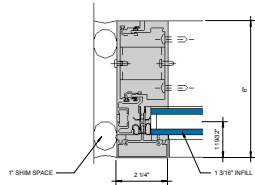

① JAMB
h = 1'-0"

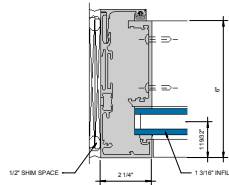

② JAMB RECEPTOR
h = 1'-0"

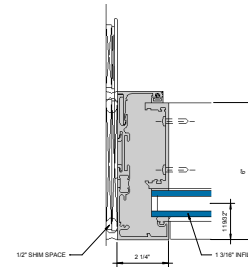

③ JAMB RECEPTOR AND STRAP ANCHOR
h = 1'-0"

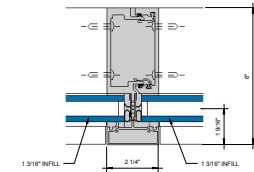

④ VERTICAL MULLION
h = 1'-0"

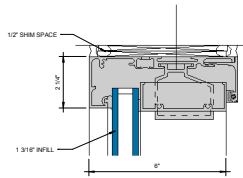

① HEAD STANDARD RECEPTOR
6" = 1'-0"

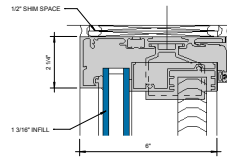

② HEAD STANDARD RECEPTOR W/
OPTIONAL BLIND POCKET
6" = 1'-0"

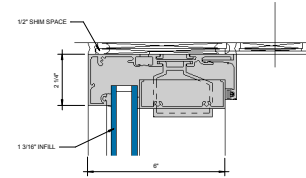

③ HEAD STANDARD RECEPTOR W/
OPTIONAL STRAP ANCHOR
6" = 1'-0"

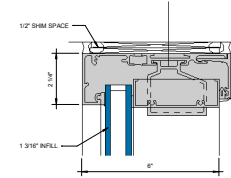

④ HEAD STANDARD RECEPTOR W/
OPTIONAL WEDGE GASKET
6" = 1'-0"

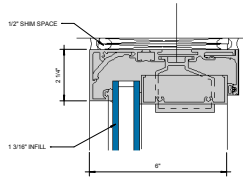

⑤ HEAD STANDARD RECEPTOR W/
REINFORCEMENT
6" = 1'-0"

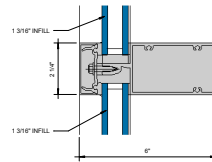

⑥ HORIZONTAL
6" = 1'-0"

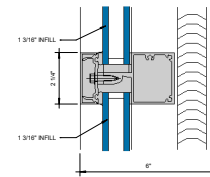

⑦ HORIZONTAL BLIND APPLICATION
6" = 1'-0"

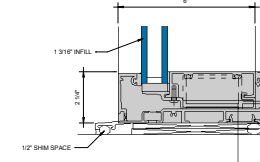

⑧ SILL STANDARD RECEPTOR
6" = 1'-0"

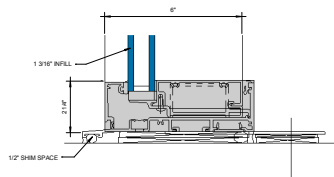

⑨ SILL STANDARD RECEPTOR W/
OPTIONAL STRAP ANCHOR
6" = 1'-0"

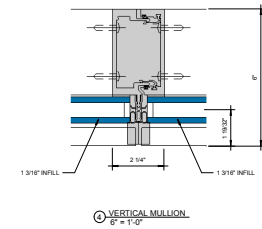
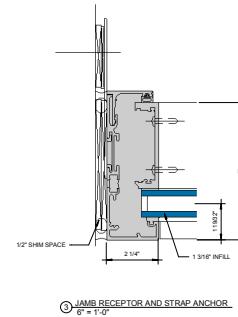
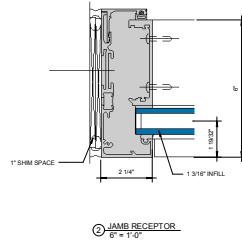
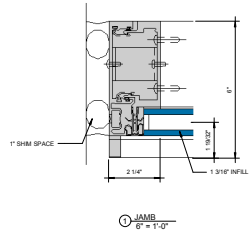

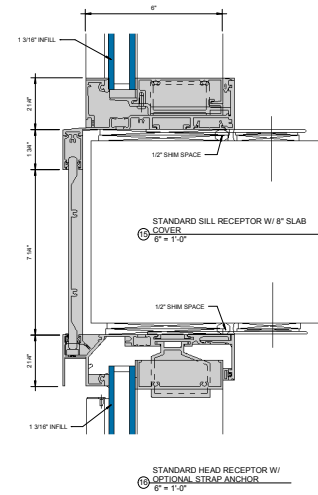
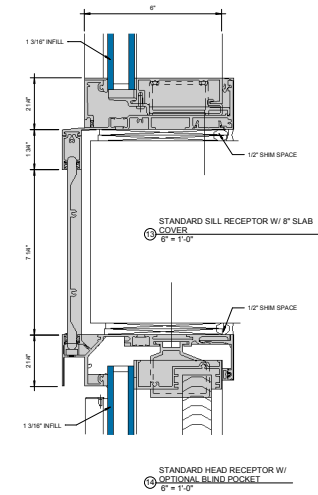
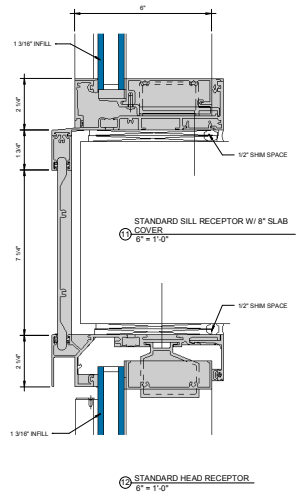
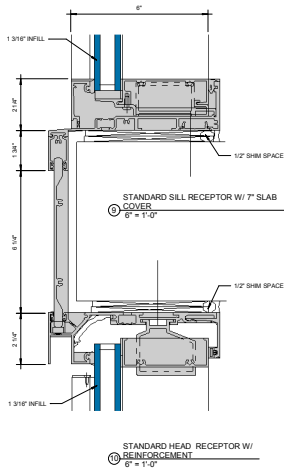
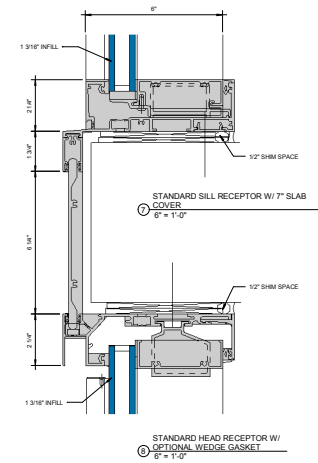
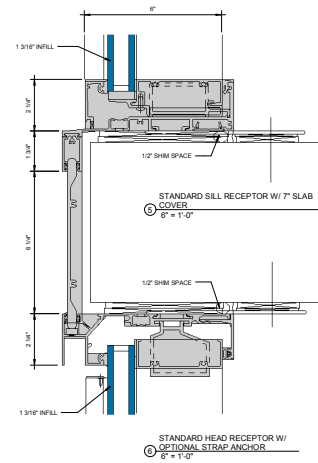
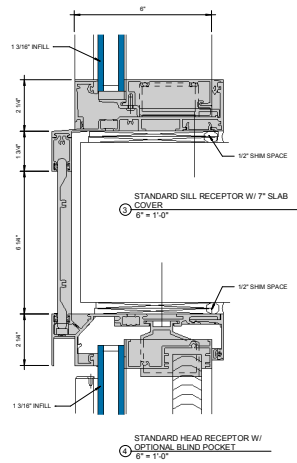
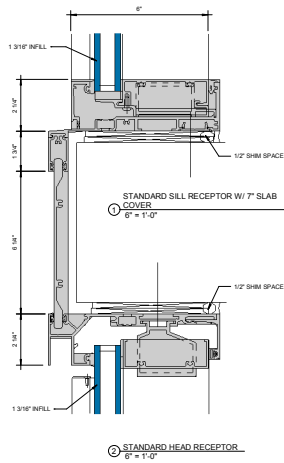

KAWNEER AN ARCONIC COMPANY

555 Guthridge Ct.
Technology Park/Atlanta
Norcross, GA 30092 USA
Tel: +1 770 449 5555

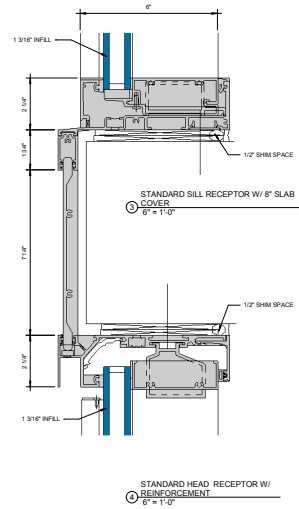
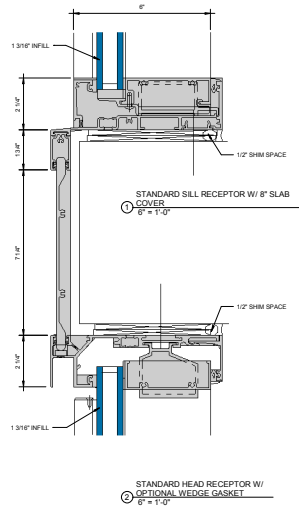

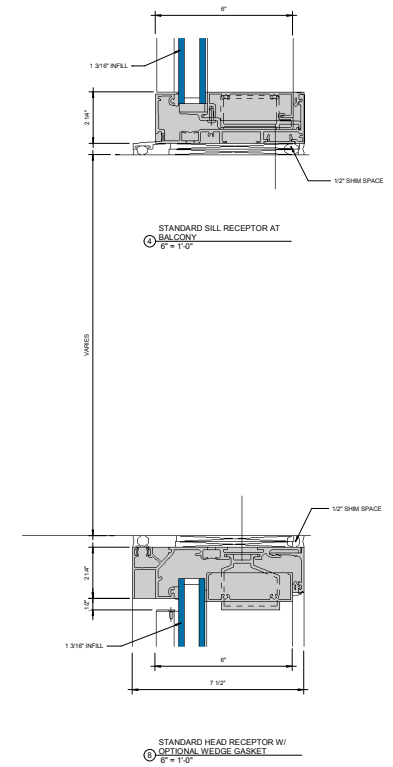
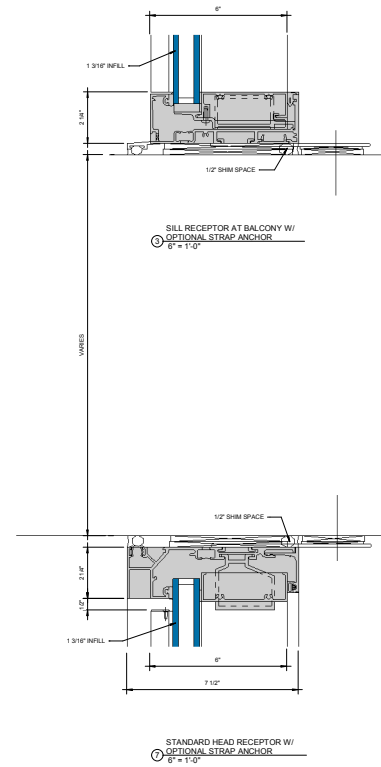
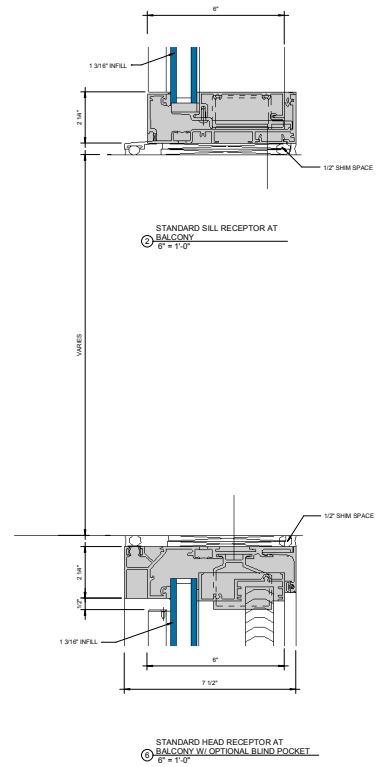
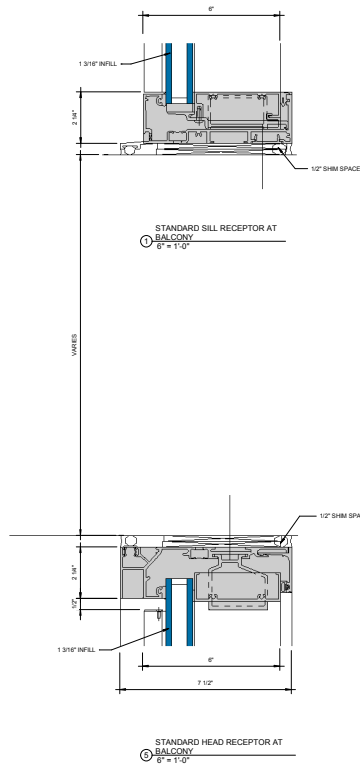

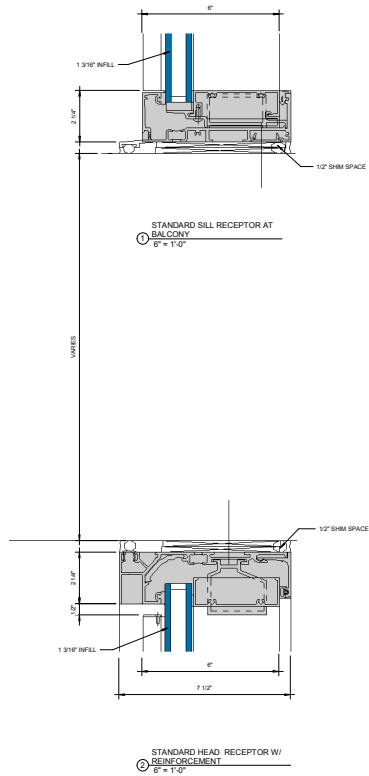

METROVIEW™ FG 601T PG WINDOW WALL - (SSG) 1-3/16” Infill Tape Glazed Framing Details Standard Receptor with Slab Cover

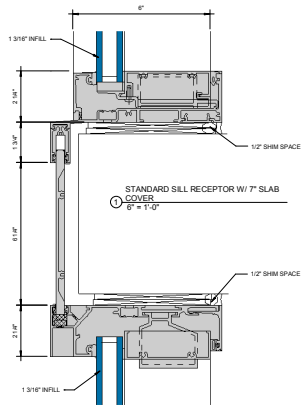

① STANDARD HEAD RECEPTOR
6" = 1'-0"

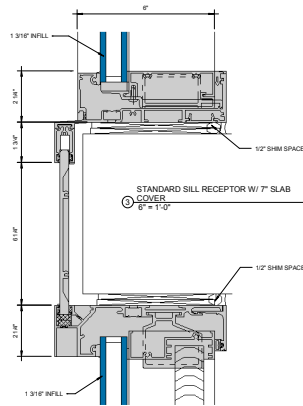

STANDARD HEAD RECEPTOR W/
② OPTIONAL BLIND POCKET
6" = 1'-0"

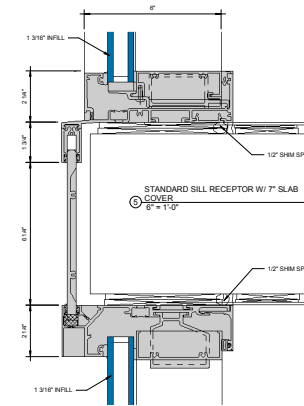

STANDARD HEAD RECEPTOR W/
③ OPTIONAL STRAP ANCHOR
6" = 1'-0"

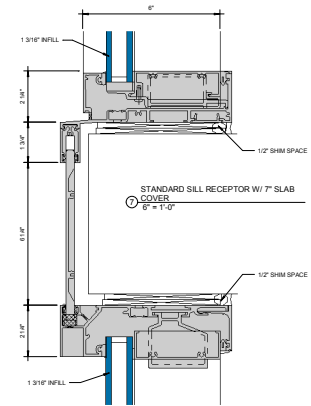

STANDARD HEAD RECEPTOR W/
④ OPTIONAL WEDGE GASKET
6" = 1'-0"

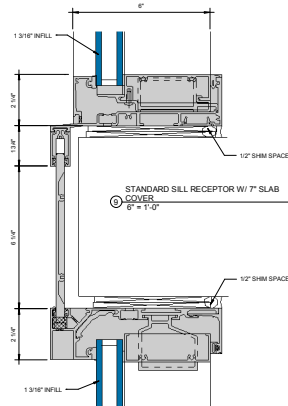

STANDARD HEAD RECEPTOR W/
⑤ REINFORCEMENT
6" = 1'-0"

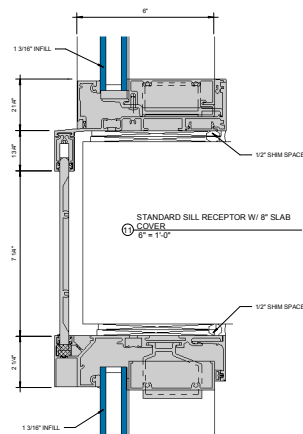

⑥ STANDARD HEAD RECEPTOR
6" = 1'-0"

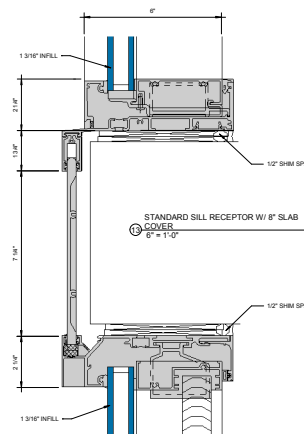

STANDARD HEAD RECEPTOR W/
⑦ OPTIONAL BLIND POCKET
6" = 1'-0"

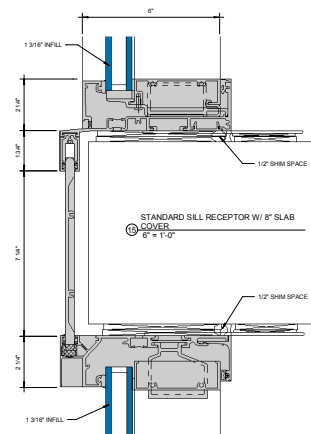

STANDARD HEAD RECEPTOR W/
⑧ OPTIONAL STRAP ANCHOR
6" = 1'-0"

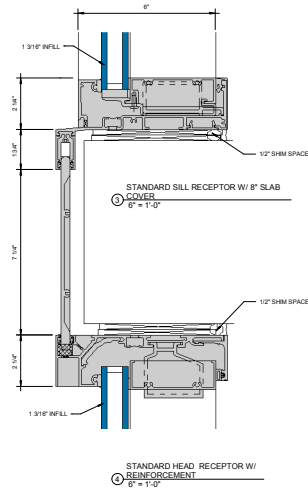
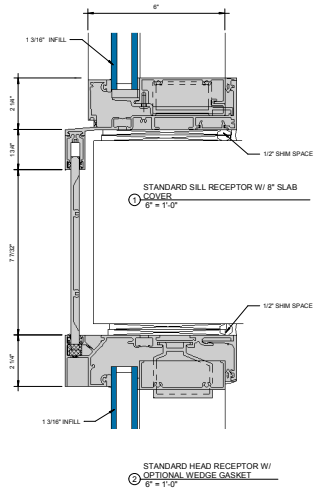

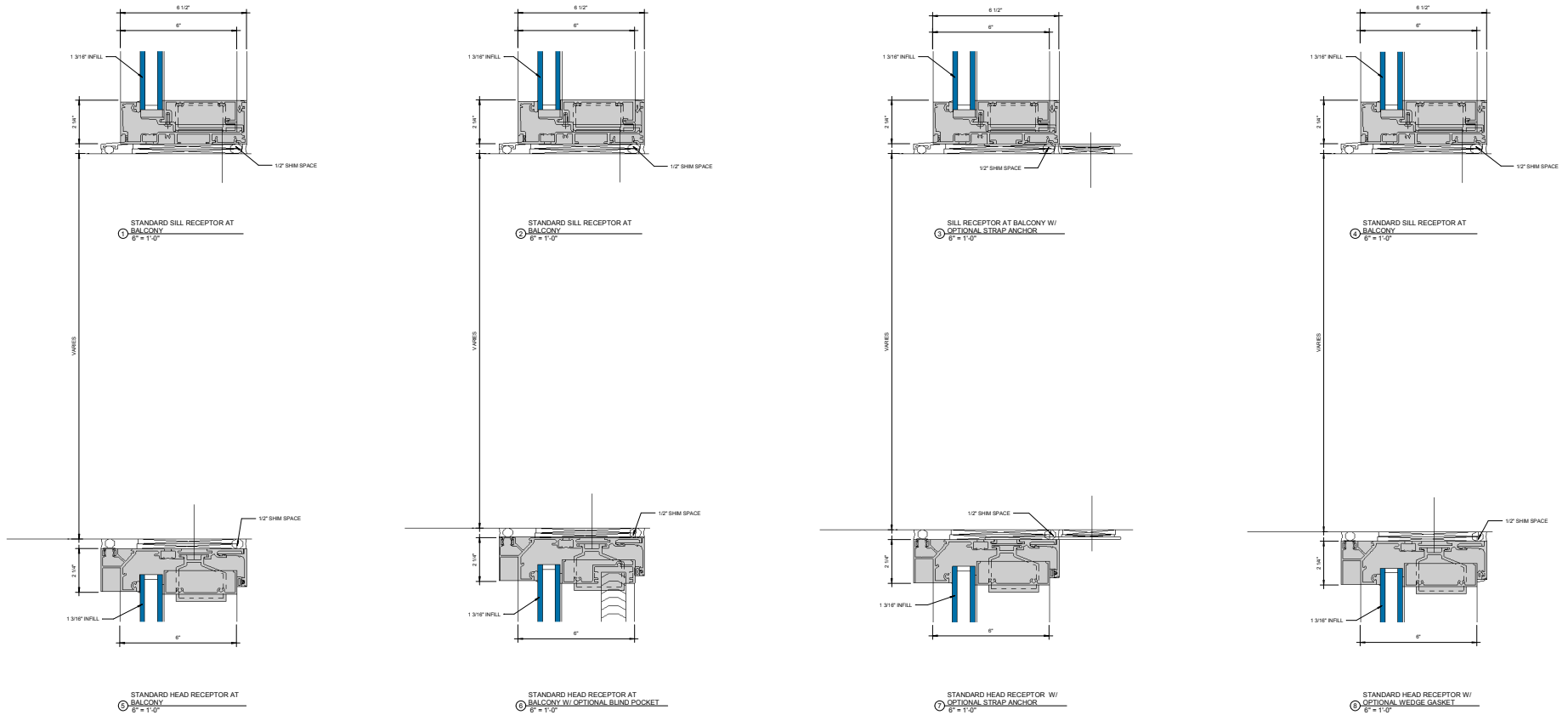

KAWNEER AN ARCONIC COMPANY

555 Guthridge Ct.
Technology Park/Atlanta
Norcross, GA 30092 USA
Tel: +1 770 449 5555

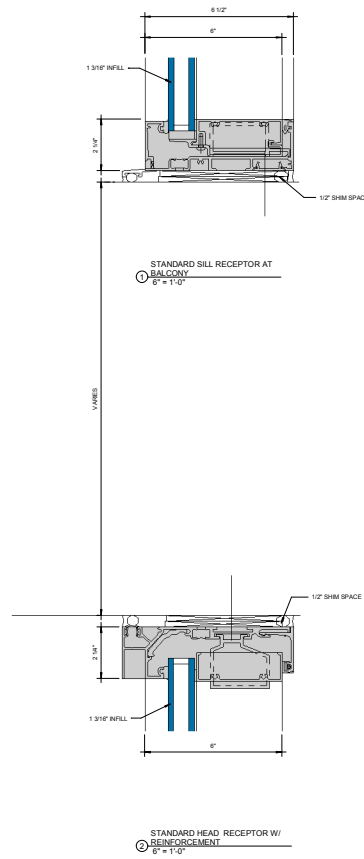

KAWNEER AN ARCONIC COMPANY

555 Guthridge Ct.
Technology Park/Atlanta
Norcross, GA 30092 USA
Tel: +1 770 449 5555

METROVIEW™ FG 601T PG WINDOW WALL - 1-3/16" Infill Tape Glazed Typical Framing Details Flush Receptor with Slab Cover

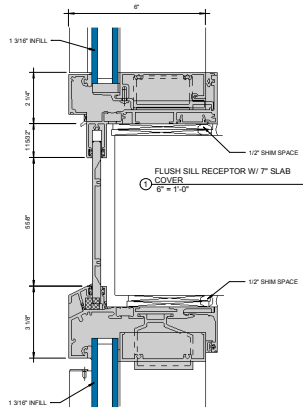

② FLUSH HEAD RECEPTOR
6" x 1'-0"

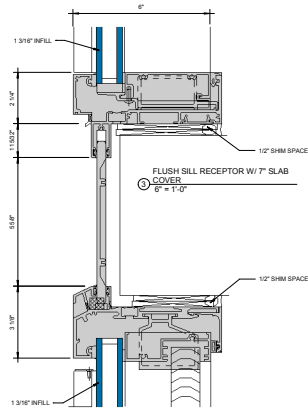

③ FLUSH SILL RECEPTOR W/ 7" SLAB
COVER
6" x 1'-0"

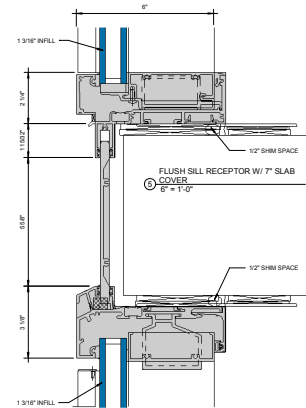

④ FLUSH HEAD RECEPTOR W/ OPTIONAL
STRAP ANCHOR
6" x 1'-0"

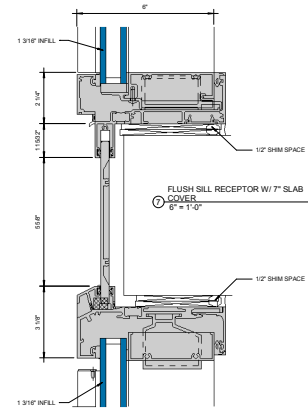

⑤ FLUSH HEAD RECEPTOR W/ OPTIONAL
WEDGE GASKET
6" x 1'-0"

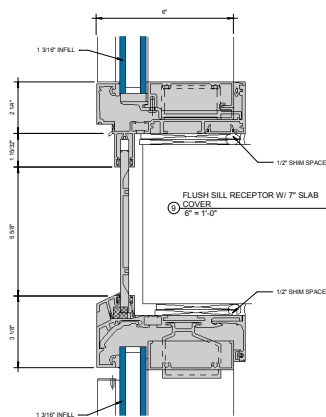

⑥ FLUSH HEAD RECEPTOR W/
REINFORCEMENT
6" x 1'-0"

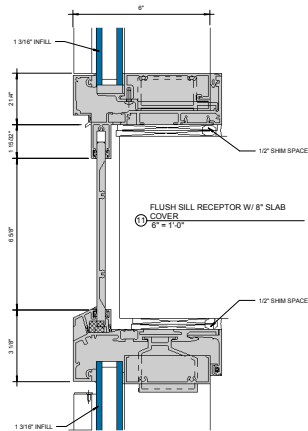

⑦ FLUSH SILL RECEPTOR
6" x 1'-0"

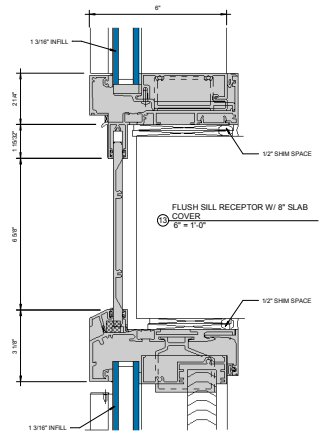

⑧ FLUSH HEAD RECEPTOR W/ OPTIONAL
BLIND POCKET
6" x 1'-0"

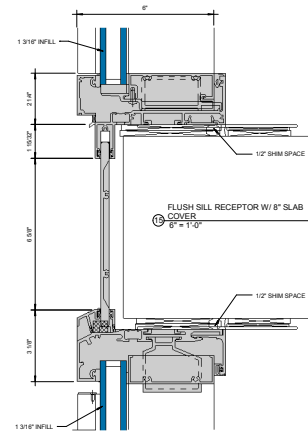

⑨ FLUSH HEAD RECEPTOR W/ OPTIONAL
STRAP ANCHOR
6" x 1'-0"

KAWNEER AN ARCONIC COMPANY

555 Guthridge Ct.
Technology Park/Atlanta
Norcross, GA 30092 USA
Tel: +1 770 449 5555

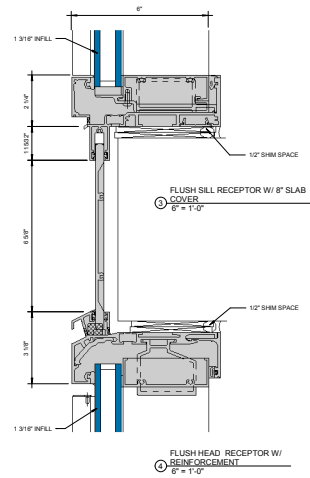
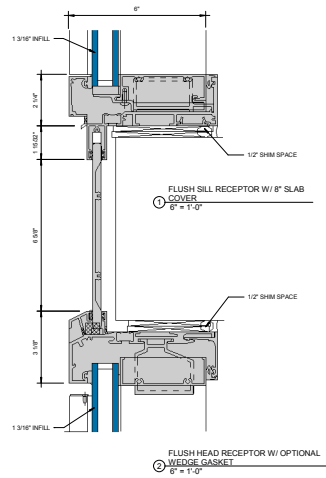

METROVIEW™ FG 601T PG WINDOW WALL - (SSG) 1-5/32” Infill Tape Glazed Typical Framing Details Flush Receptor with Slab Cover

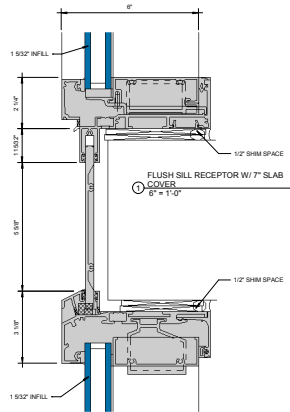

② FLUSH HEAD RECEPTOR
6" = 1'-0"

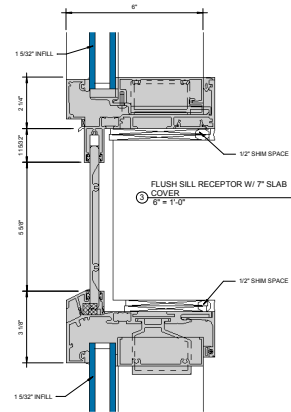

④ FLUSH HEAD RECEPTOR W/ OPTIONAL
BLIND POCKET
6" = 1'-0"

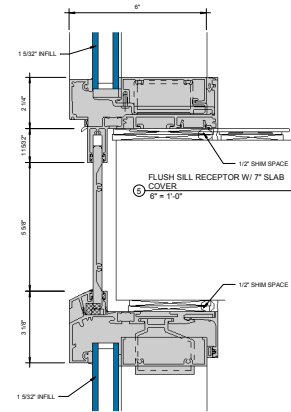

③ FLUSH HEAD RECEPTOR W/ OPTIONAL
STRAP ANCHOR
6" = 1'-0"

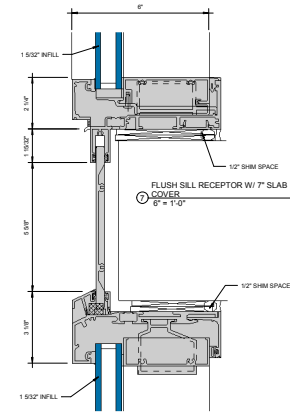

⑤ FLUSH HEAD RECEPTOR W/ OPTIONAL
WEDGE GASKET
6" = 1'-0"

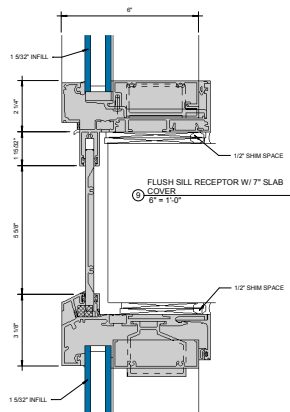

⑩ FLUSH HEAD RECEPTOR W/
REINFORCEMENT
6" = 1'-0"

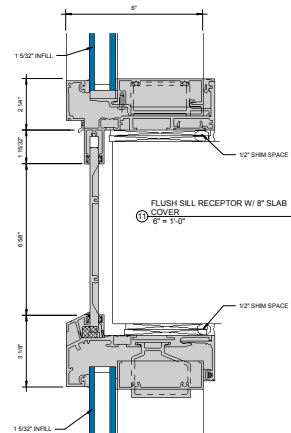

⑪ FLUSH HEAD RECEPTOR
6" = 1'-0"

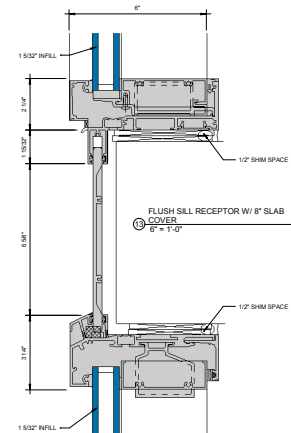

⑭ FLUSH HEAD RECEPTOR W/ OPTIONAL
BLIND POCKET
6" = 1'-0"

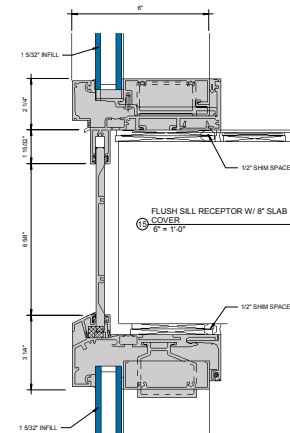

⑬ FLUSH HEAD RECEPTOR W/ OPTIONAL
STRAP ANCHOR
6" = 1'-0"

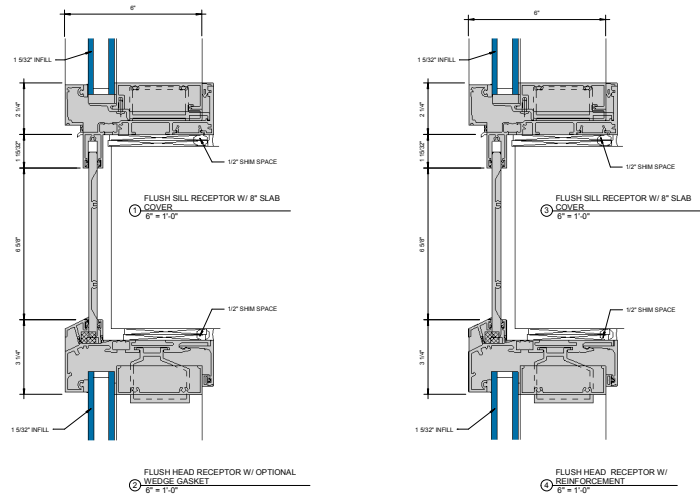

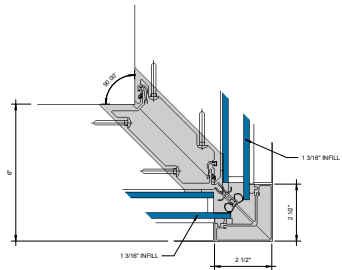

① 90° OUTSIDE CORNER
G = 1'-0"

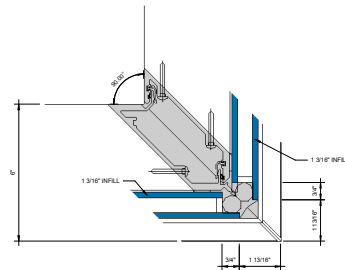

② 90° OUTSIDE CORNER (SSG)
G = 1'-0"

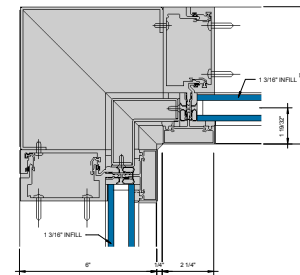

③ 90° INSIDE CORNER
G = 1'-0"

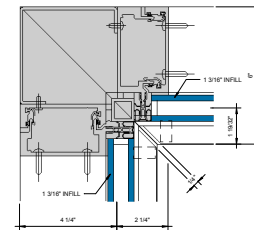

④ 90° INSIDE CORNER (SSG)
G = 1'-0"

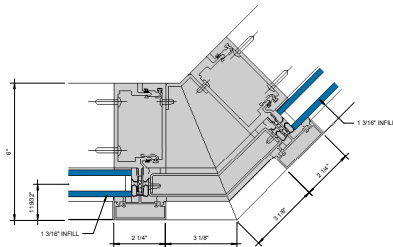

⑤ 135° OUTSIDE CORNER
G = 1'-0"

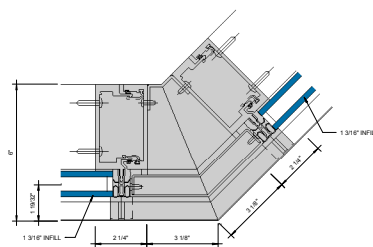

⑥ 135° OUTSIDE CORNER (SSG)
G = 1'-0"

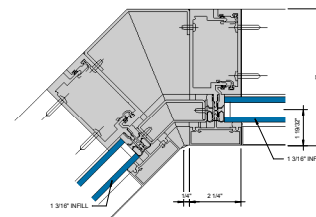

⑦ 135° INSIDE CORNER
G = 1'-0"

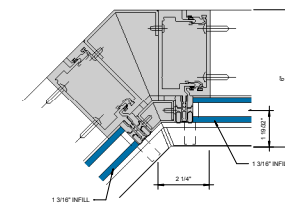

⑧ 135° INSIDE CORNER (SSG)
G = 1'-0"

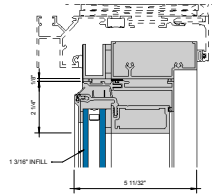

GLASSvent UT HEAD AT HEAD
RECEPTOR POCCOS
Ø = 1-0"

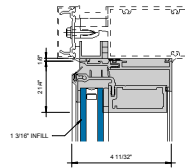

GLASSvent UT HEAD AT HORIZONTAL
POCCOS
Ø = 1-0"

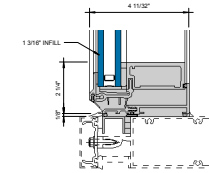

GLASSvent UT SILL AT HORIZONTAL
POCCOS
Ø = 1-0"

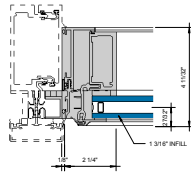

GLASSvent UT JAMB (LH) AT VERTICAL
POCCOS
Ø = 1-0"

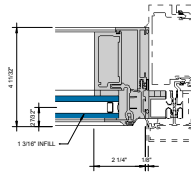

GLASSvent UT JAMB (RH) AT VERTICAL
POCCOS
Ø = 1-0"

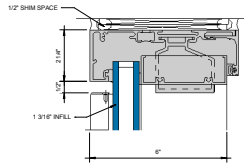

① HEAD PUNCHED OPENING RECEPTOR
6" = 1'-0"

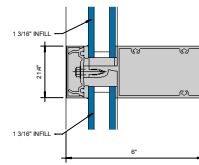

② HORIZONTAL
6" = 1'-0"

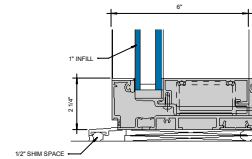

③ SILL PUNCHED OPENING RECEPTOR
6" = 1'-0"

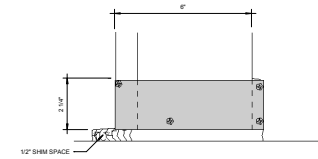

④ SILL END CAP @ DOOR JAMB
6" = 1'-0"

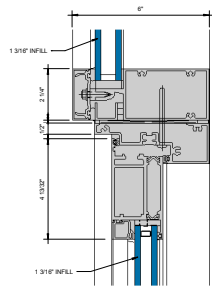

⑤ 2000T TERRACE DOOR HEADER @
HORIZONTAL
6" = 1'-0"

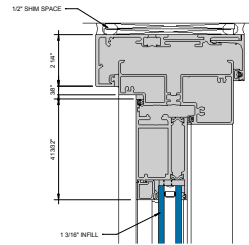

⑥ 2000T TERRACE DOOR HEADER W/
PUNCHED OPENING RECEPTOR
6" = 1'-0"

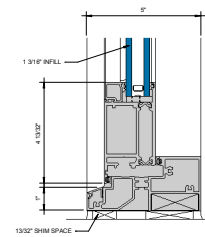

⑦ 2000T TERRACE DOOR SILL
6" = 1'-0"

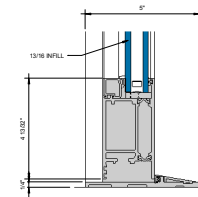

⑧ 2000T TERRACE DOOR LOW PROFILE
SILL
6" = 1'-0"

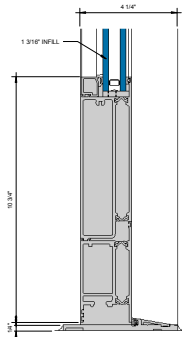

⑨ 2000T TERRACE DOOR 10\"/>

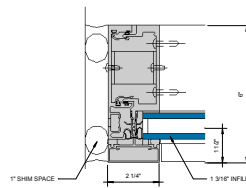

⑩ JAMB
6" = 1'-0"

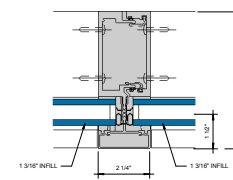

⑪ VERTICAL MULLION
6" = 1'-0"

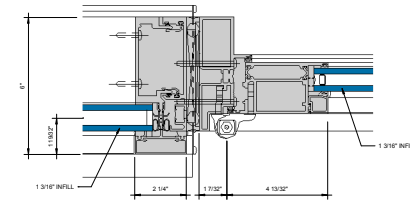

⑫ DOOR JAMB @ HINGE STILE
6" = 1'-0"

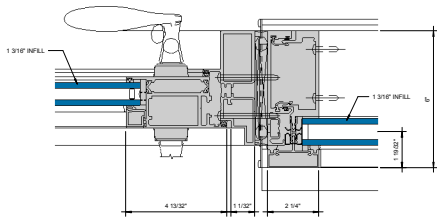

① DOOR JAMB @ LOCK STILE
Ø = 1'-0"

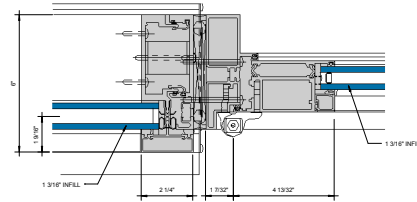

② DOOR JAMB @ HINGE STILE
Ø = 1'-0"

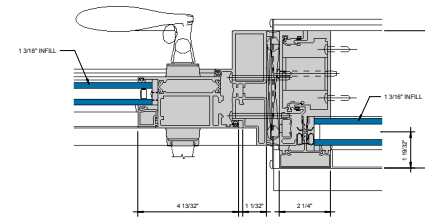

③ DOOR JAMB @ LOCK STILE
Ø = 1'-0"

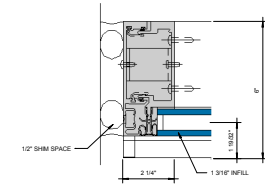

④ ALT. SSG JAMB
Ø = 1'-0"

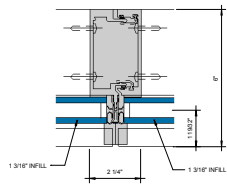

⑤ ALT. SSG VERTICAL MULLION
Ø = 1'-0"

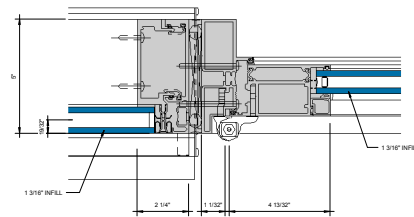

⑥ ALT. SSG DOOR JAMB @ HINGE STILE
Ø = 1'-0"

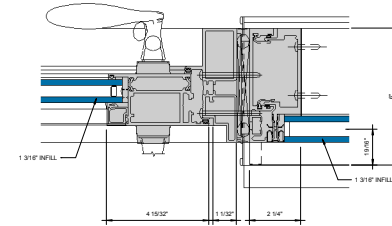

⑦ ALT. SSG DOOR JAMB @ LOCK STILE
Ø = 1'-0"

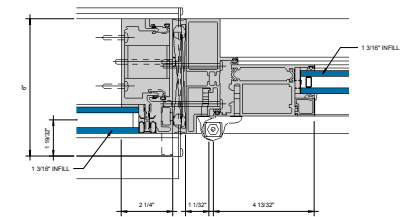

⑧ ALT. SSG DOOR JAMB @ HINGE STILE
Ø = 1'-0"

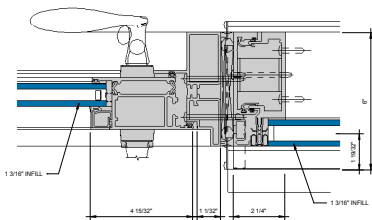

⑨ ALT. SSG DOOR JAMB @ LOCK STILE
Ø = 1'-0"

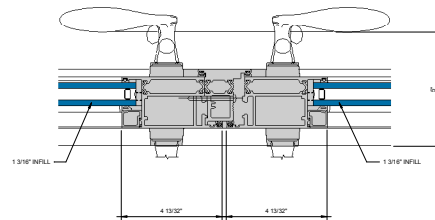

⑩ 2000T DOOR MEETING STILES
Ø = 1'-0"

KAWNEER AN ARCONIC COMPANY

555 Guthridge Ct.
Technology Park/Atlanta
Norcross, GA 30092 USA
Tel: +1 770 449 5555

METROVIEW™ FG 601T PG WINDOW WALL - 1-3/16" Infill Tape Glazed with 2000T Terrace Door – Inswing Typical Entrance Framing Details

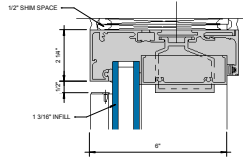

① HEAD PUNCHED OPENING RECEPTOR
6" = 1'-0"

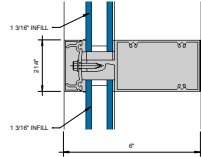

② HORIZONTAL
6" = 1'-0"

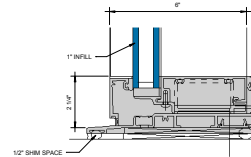

③ SILL PUNCHED OPENING RECEPTOR
6" = 1'-0"

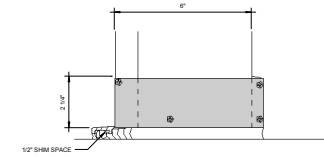

④ SILL END CAP @ DOOR JAMB
6" = 1'-0"

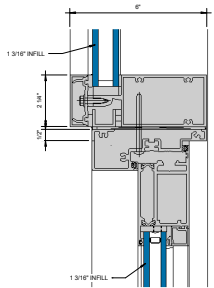

⑤ 2000T TERRACE DOOR HEADER @
HORIZONTAL
6" = 1'-0"

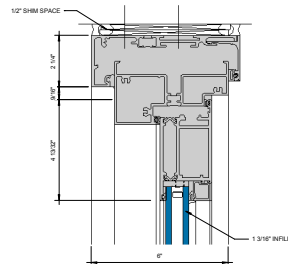

⑥ 2000T TERRACE DOOR HEADER W/
PUNCHED OPENING RECEPTOR
6" = 1'-0"

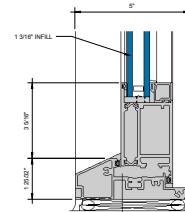

⑦ 2000T TERRACE DOOR SILL
6" = 1'-0"

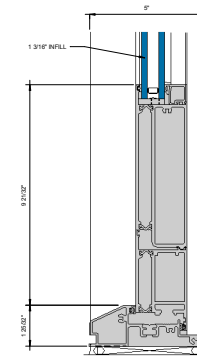

⑧ 2000T TERRACE DOOR 10" TALL SILL
6" = 1'-0"

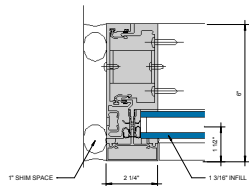

⑨ JAMB
6" = 1'-0"

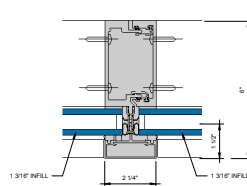

⑩ VERTICAL MULLION
6" = 1'-0"

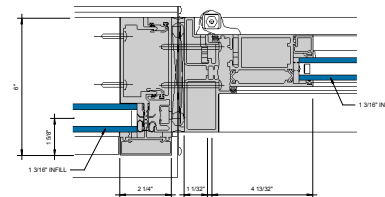

⑪ DOOR JAMB @ HINGE STILE
6" = 1'-0"

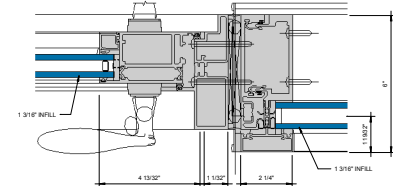

⑫ DOOR JAMB @ LOCK STILE
6" = 1'-0"

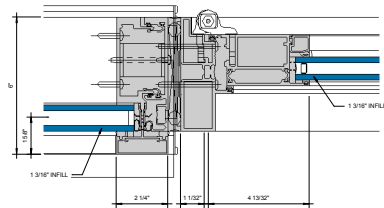

1 DOOR JAMB @ HINGE STILE
6" = 1'-0"

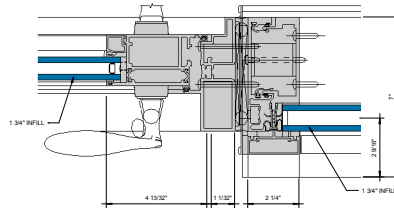

2 DOOR JAMB @ LOCK STILE
6" = 1'-0"

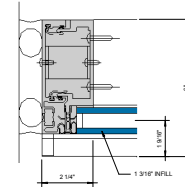

3 ALT. SSG JAMB
6" = 1'-0"

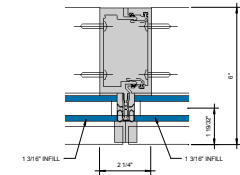

4 ALT. SSG VERTICAL MULLION
6" = 1'-0"

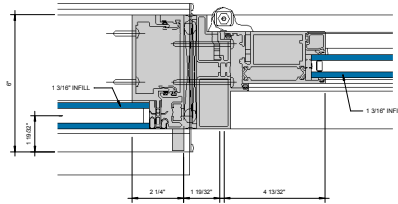

5 ALTERNATE. SSG DOOR JAMB @ HINGE
STILE
6" = 1'-0"

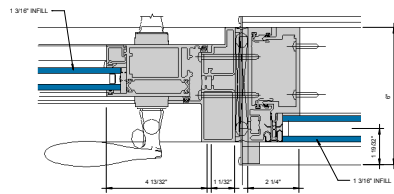

6 ALTERNATE. SSG DOOR JAMB @ LOCK
STILE
6" = 1'-0"

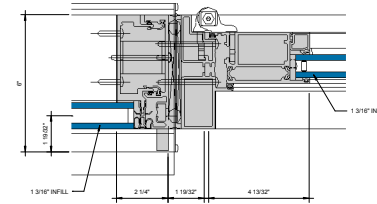

7 ALTERNATE. SSG DOOR JAMB @ HINGE
STILE
6" = 1'-0"

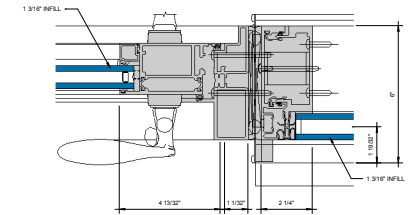

8 ALTERNATE. SSG DOOR JAMB @ LOCK
STILE
6" = 1'-0"

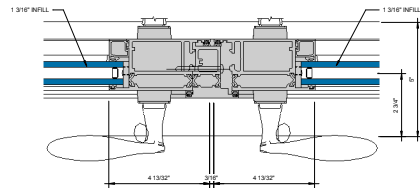

9 MEETING STILES
6" = 1'-0"

KAWNEER AN ARCONIC COMPANY

555 Guthridge Ct.
Technology Park/Atlanta
Norcross, GA 30092 USA
Tel: +1 770 449 5555